



ROC-2HE

Reverse Osmosis System Controller Documentation

*Document Revised April, 2018
(TB-1 Rev D2)*

©2006-2018 iControls Technologies Inc.

iControls Technologies Inc.
1821 Empire Industrial Court, Suite A
Santa Rosa, CA 95403
ph (425) 577-8851
www.icontrols.net

Welcome.

Thank you for purchasing an iControls controller.

You made a good choice in choosing iControls. You can expect years of trouble-free service. With a design based on feedback from leaders in the RO field plus our own experience in RO system design and manufacture, iControls RO controllers are truly best in class.

As good as our controllers are, there's always room for improvement. If you have an experience, idea or input either positive or negative we'd love to hear from you.

Again, thanks for your purchase. Welcome to the community of iControls users.



David Spears

President,
iControls Technologies Inc.

david@icontrols.net

Table of Contents

Description	Page
Specifications, Table 1 _____	4
Schematic, Figure 1 _____	5
Controller Overview, Figure 2_____	6
Controller Detail: CPU-4 _____	7
Controller Detail: TB-1_____	8
Conductivity Probe Installation, Figure 5 _____	9
Controller Programming: Accessing Hidden Menus, Figure 6 _____	10
Controller Programming: Menu Navigation, Figure 7 _____	11
Controller Programming: Program Selections, Table 2 _____	12
Controller Fault Displays _____	13
Controller Programming: Programming Interface Overview _____	14
Warranty _____	15

Table 1. Specifications

Inputs

Tank level switches	(2) Normally-Closed. <i>Can be used with a single level switch.</i>
Inlet pressure switch	Normally-Open.
Pretreat lockout switch	Normally-Open. The Tank, Low Pressure and Pretreat inputs are 50% duty cycle square wave, 10VDC peak @ 10mA max. The switch inputs are dry contacts only. Applying voltage to these terminals will damage the controller.
Controller Power	110-120/208-240 VAC, 60/50Hz (Range: 110-240 VAC)
Permeate Conductivity	0-3000 PPM, 0-6000 μ s (standard sensor, CP-1, K=.75)
Feed Conductivity (opt)	0-3000 PPM, 0-6000 μ s (standard sensor, CP-1, K=.75)

Output Circuit Ratings

Feed Solenoid	1A. <i>Voltage is the same as motor/supply voltage.</i>
Flush Solenoid	1A. <i>Voltage is the same as motor/supply voltage.</i>
Motor	1.0 HP/110-120V, 2.0 HP/208-240V.

Circuit Protection

Main Power Fuse (110V)	F1 3AG 20 Amp	LittleFuse 314020(P)
	F1 3AG 4 Amp	LittleFuse 312004(P) (Motor contactor coil)
Main Power Fuse (208/240V)	F1 3AG 15 Amp	LittleFuse 314015(P) (For up to 2 HP)
Power Supply Fuse	F2 3AG 1/4 Amp	LittleFuse 312.250
Relay Fuse	F3 3AG 2 Amp	LittleFuse 312002

Note: The fuses shown above are for supplemental protection only. Branch circuit protection and disconnect means must be provided externally.

Other

Dimensions	7" tall, 7" wide, 4" deep. Nema 4X* Polycarbonate Hinged Enclosure.
Weight	2.6 lb. (<i>Basic Configuration, not including optional wire harness, etc..</i>)
Environment	0-50°C, 10-90%RH (non-condensing) *Note: After our modification the enclosure rating is Nema 1.

Figure 1. Simplified Schematic

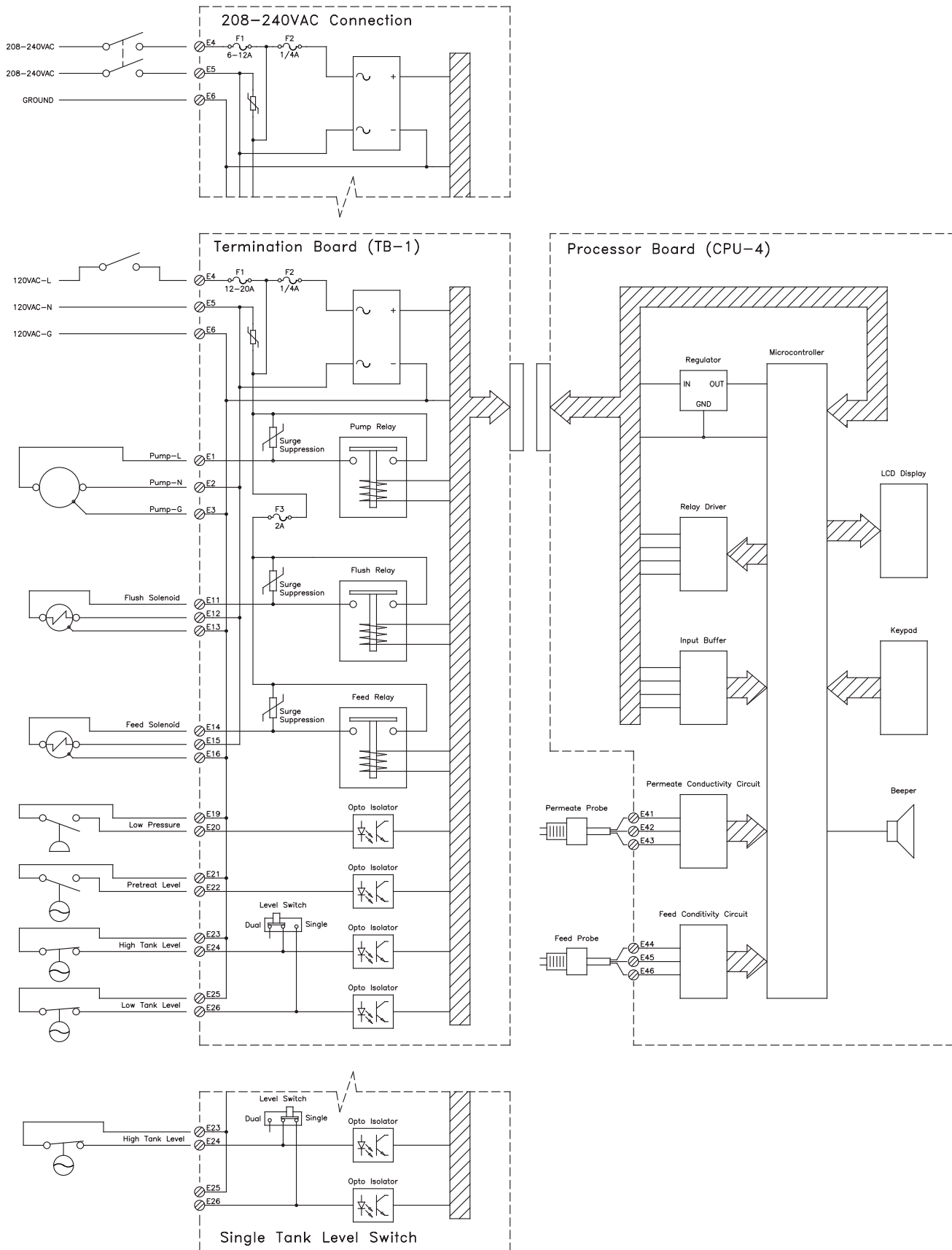

Figure 2. Controller Overview

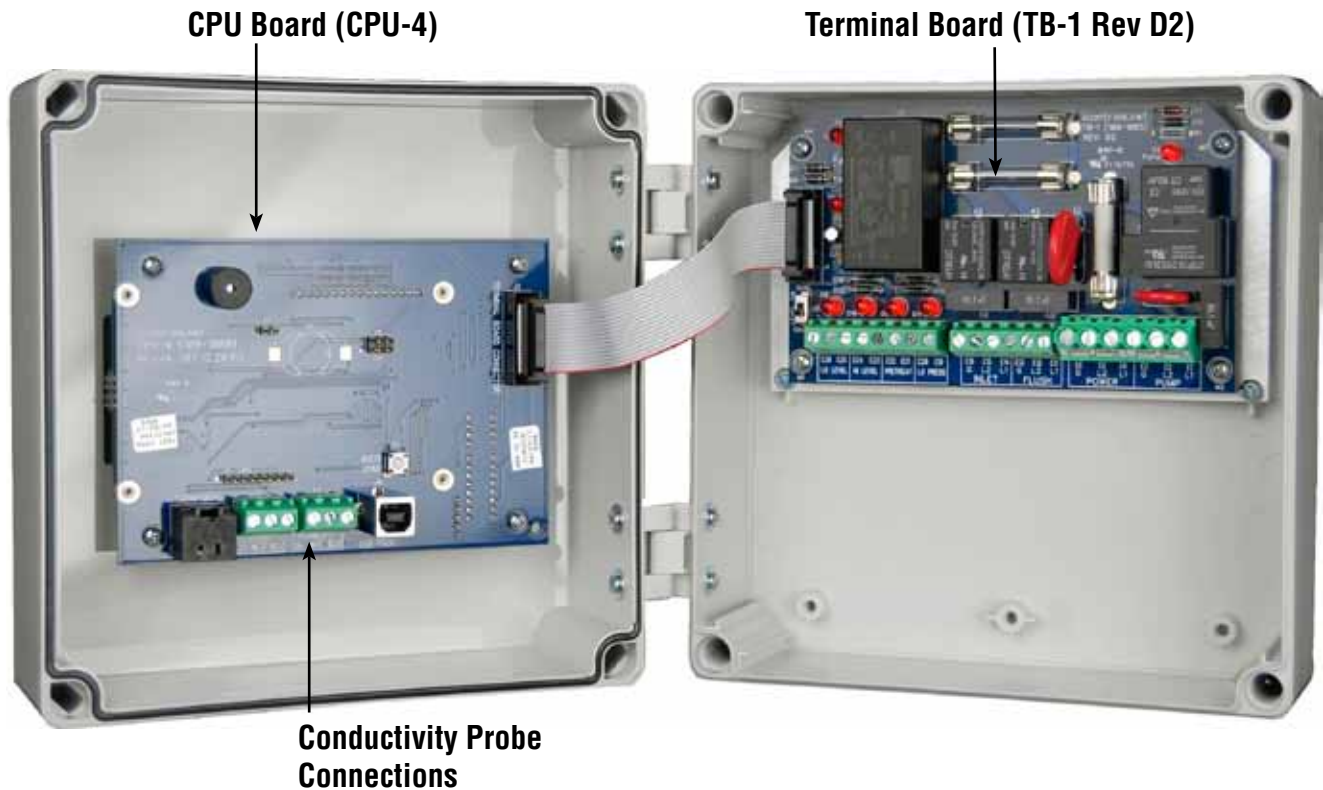
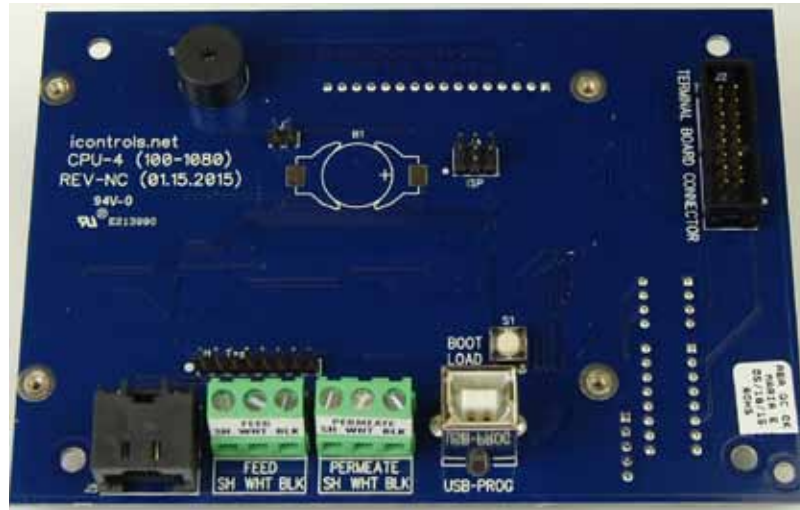

Figure 3. Controller Detail: CPU-4

Typical Configuration



Detailed View

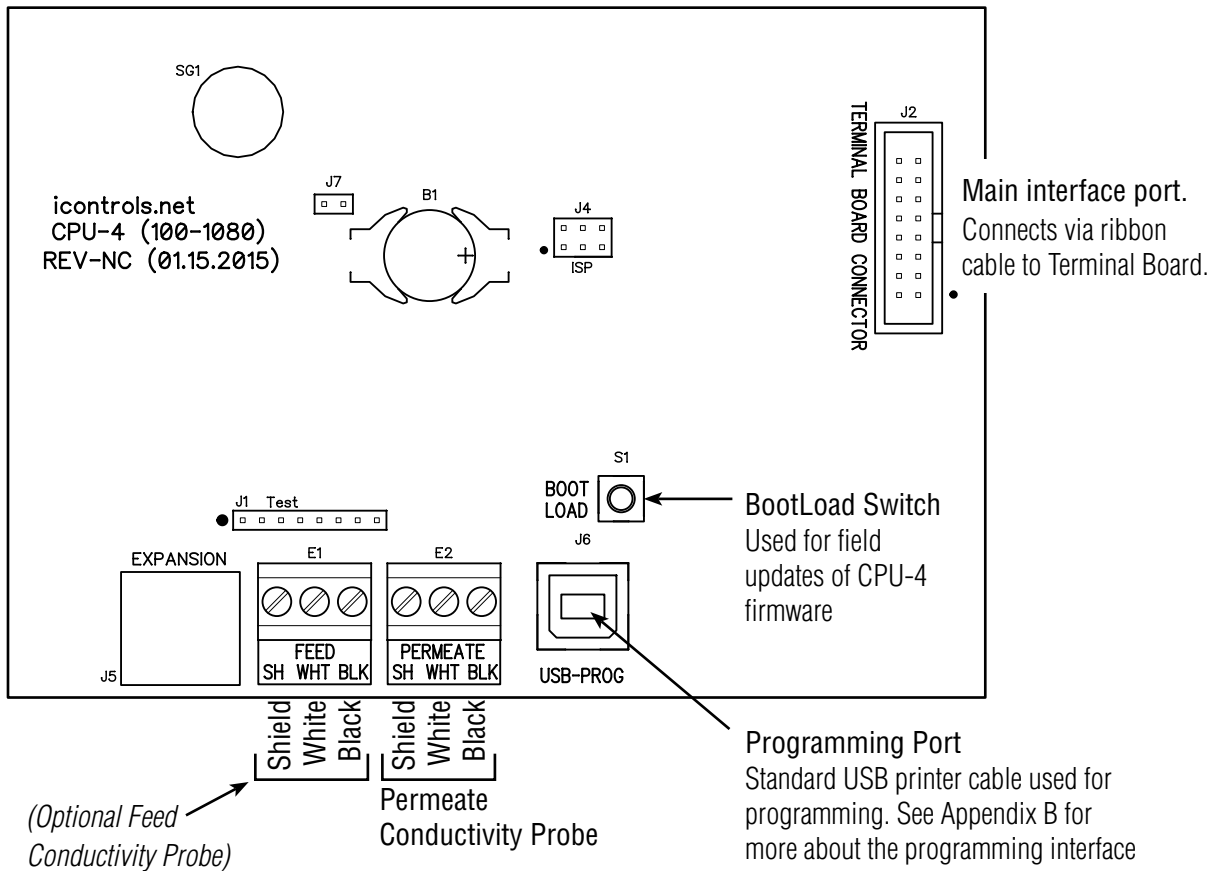
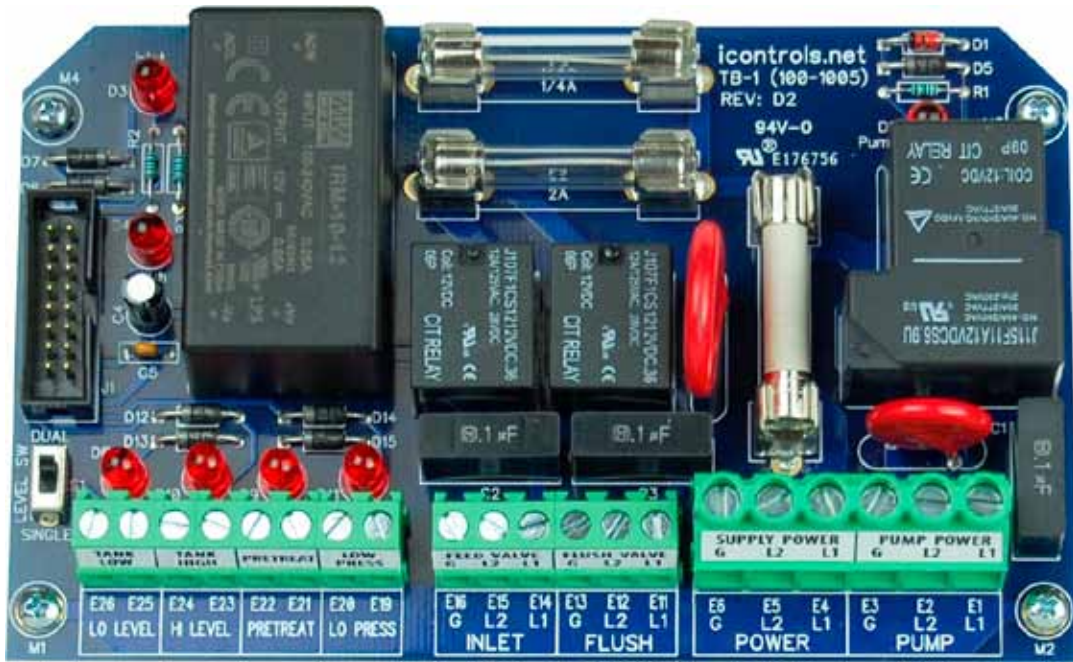

Figure 4. Controller Detail: Terminal Board, TB-1 (Rev D2) (See Fig. 1 for schematic)



Pump LED
Illuminates when the motor relay is energized.

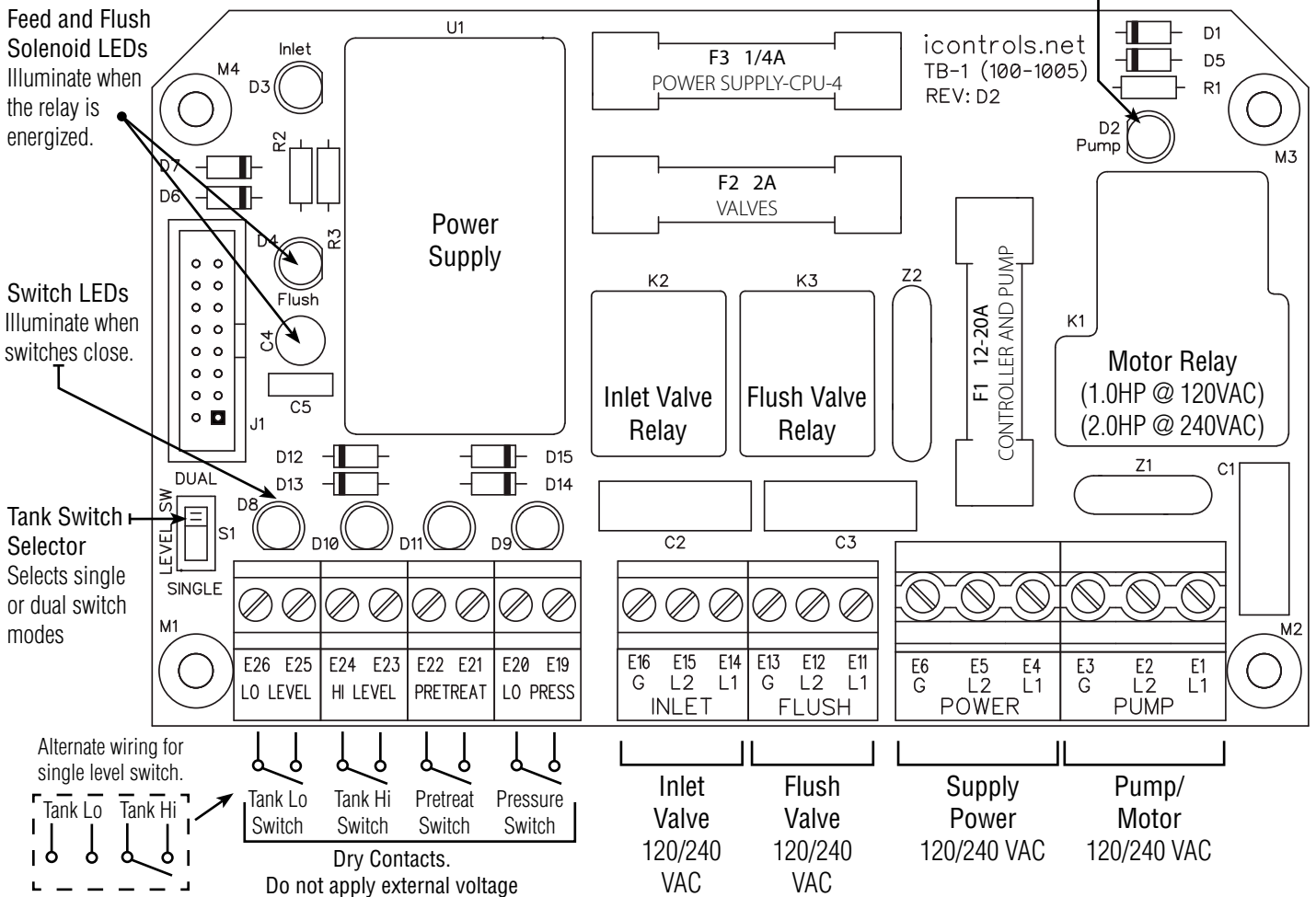

Figure 5. Conductivity Probe Installation



Install the Conductivity Probe in the "Run" of a Tee or equivalent location. Orient the probe so that air can not become trapped in the area near the probe.

Figure 6. Controller Programming. Accessing the hidden menus.

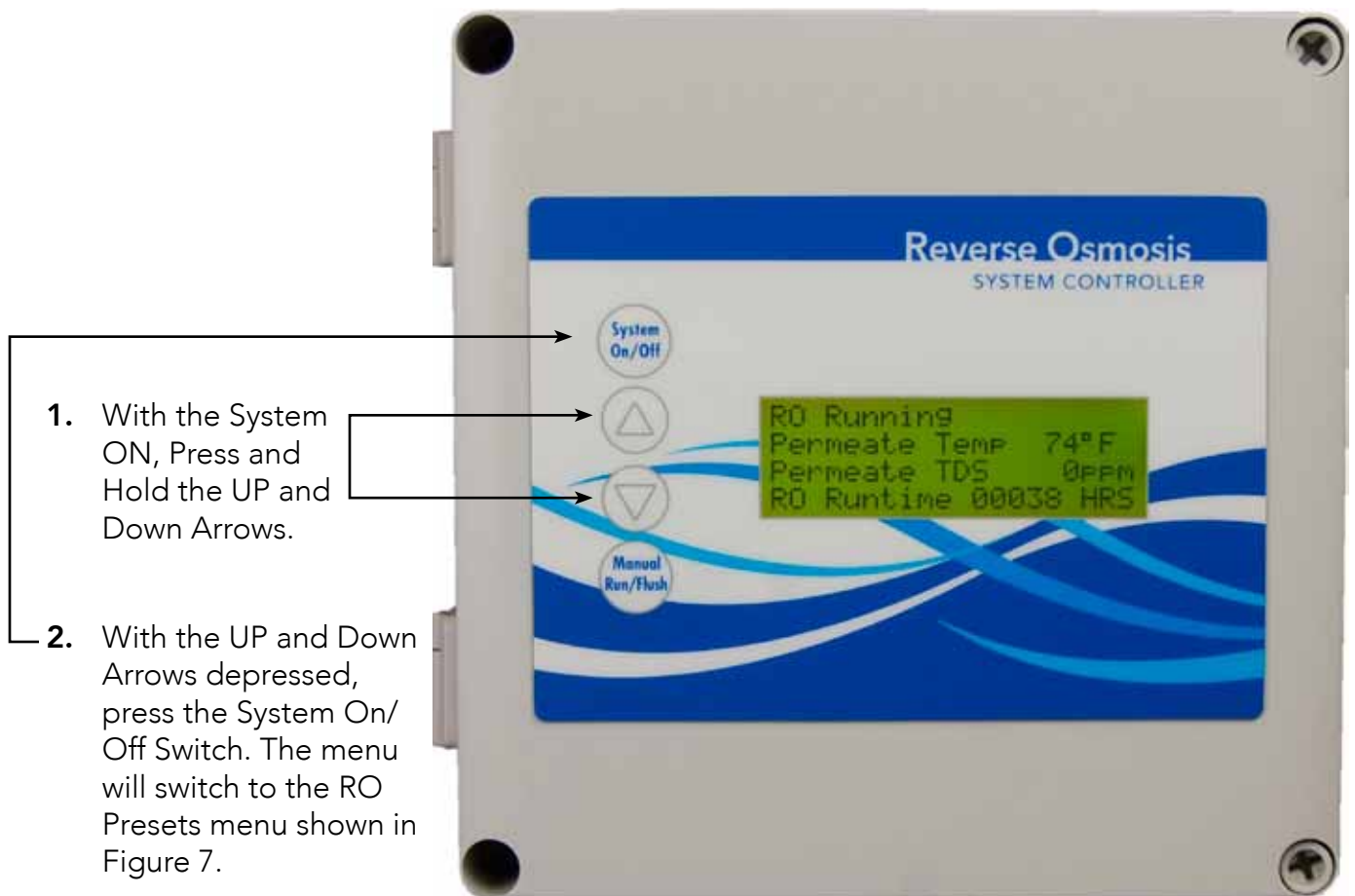
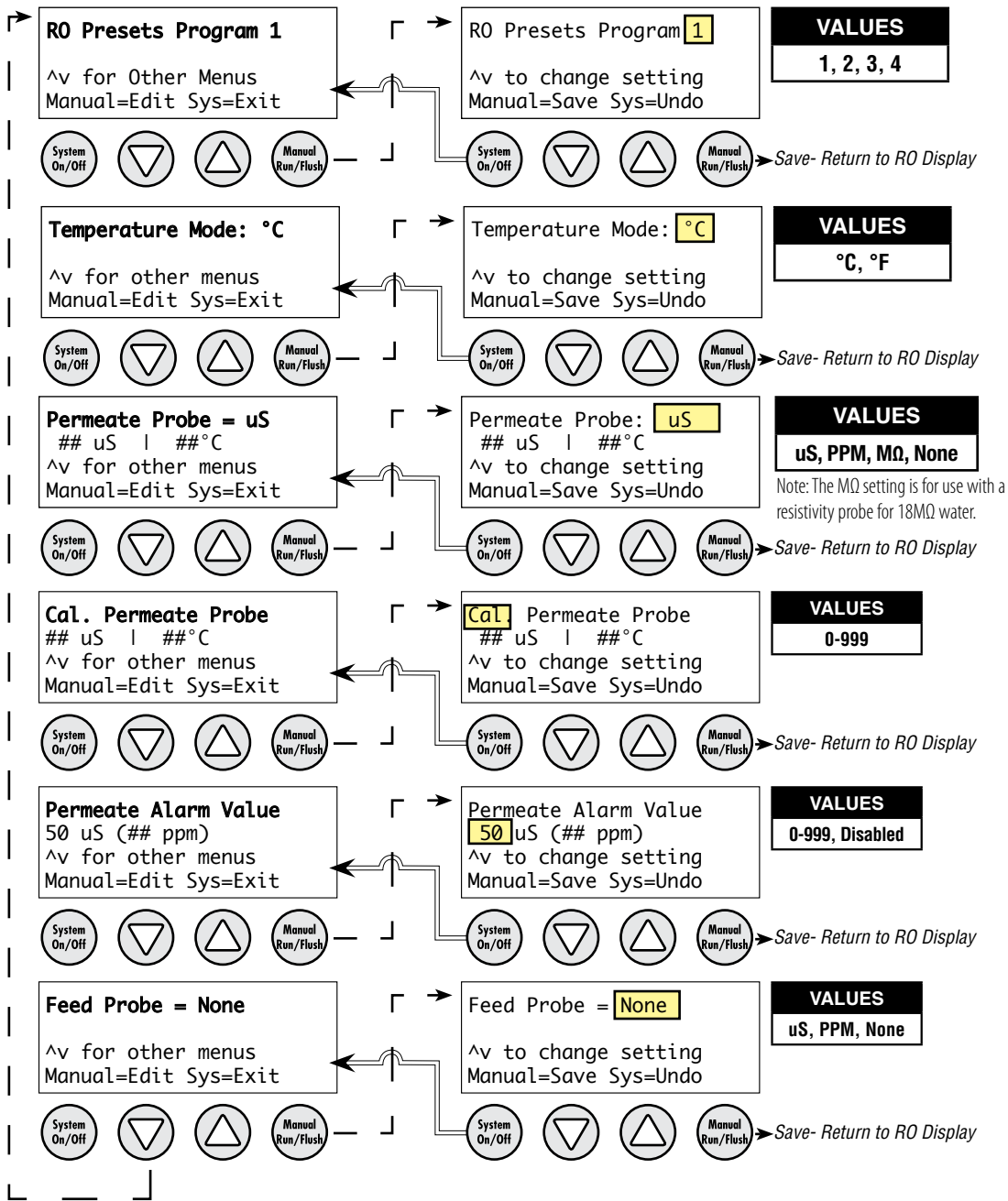

Figure 7. Controller Programming: Menu Navigation



This is a partial view of the internal menus. Additional editable items include: Language, Audible Alarm (ON/OFF), WQ Loss of Signal setting, Hardware & Firmware Version and more.

Table 2. Controller Programming: ROC-2HE Program Selections

The controller has 4 separate user-selectable sets of settings for configuring the RO. The factory default settings are shown below. The settings are identical except for variations in the flush behavior.

- **Program 1, High Pressure flush.**
- **Program 2, No Flush**
- **Program 3, Permeate Flush, (low pressure, inlet valve closed)**
- **Program 4, Low Pressure, feed water flush**
- See the previous page for instructions on how to access the menu for selecting these programs.
- See Appendix A for a detailed explanation of the Parameters and their affect on the RO's operation.

Parameter	Value	Program 1	Program 2	Program 3	Program 4
Tank Level Switch delay (actuation and de-actuation)	Seconds	2	2	2	2
Pressure Switch delay (actuation and de-actuation)	Seconds	2	2	2	2
Pretreat Switch delay (actuation and de-actuation)	Seconds	2	2	2	2
Pump start delay	Seconds	10	10	10	10
Inlet Solenoid stop delay	Seconds	1	1	1	1
Pump start retry interval (restart delay after LP fault)	Seconds	60	60	60	60
Low pressure fault shutdown, # of faults	Faults	5	5	5	5
Low pressure fault shutdown, time period to count faults	Minutes	10	10	10	10
Low pressure fault shutdown, reset after shutdown	Minutes	60	60	60	60
Low pressure timeout fault	Seconds	60	60	60	60
Flush Behavior		High Pressure	No Flush	Permeate Flush	Low Pressure Flush
Startup Flush: Minutes from last flush	Minutes	0	0	0	0
Startup Flush: Duration	Seconds	0	0	0	30
Periodic Flush: Interval	Minutes	60	0	0	0
Periodic Flush: Duration	Seconds	30	0	0	0
Shutdown Flush: Time from last flush	Minutes	10	0	0	0
Shutdown Flush: Minimum operation	Minutes	30	0	0	0
Shutdown Flush: Duration	Seconds	60	0	60	60
Idle Flush: Interval *	Minutes	0	0	0	0
Idle Flush: Duration *	Seconds	0	0	0	0
Timed Manual Run	Minutes	5	5	5	5
Timed Manual Flush	Minutes	5	0	5	5

* These features are disabled by default due to the potential for confusion on the part of end-users in the field. They can be enabled when needed via the OEM PC programming interface which allows changes to all of the values shown above.

Controller Fault Condition Displays

Below are examples and explanations of the displays which accompany the fault conditions possible on the CPU-4. Fault conditions always indicate a problem of some sort which requires corrective action. the displays provide sufficient information to recognize the source of the fault and the required corrective action.

Low Pressure Fault: *(System is responding to low pressure condition per system settings)*

Line 1 "Service Fault"

Line 2 "Low Feed Pressure"

Line 3

Line 4 "Restart in MM:SS"

Pre Treat Fault: *(Pretreat Switch is closed indicating problem with pretreat system).*

Line 1 "Service Fault"

Line 2 "Pretreat"

Line 3

Line 4 "Check Pretreat Sys."

Permeate Conductivity Fault: *(Permeate conductivity is higher than the alarm setpoint.)*

Line 1 "Service Fault"

Line 2 "Permeate TDS xxx ppm" or "Permeate Cond xxx uS"

Line 3 "Alarm SP xxx ppm" or "Alarm SP xxx uS"

Line 4 "To Reset Push OFF/ON"

Feed Conductivity Fault: *(Feed conductivity is higher than the alarm setpoint.)*

Line 1 "Service Fault"

Line 2 "Feed TDS xxx ppm" or "Feed Cond xxx uS"

Line 3 "Alarm SP xxx ppm" or "Alarm SP xxx uS"

Line 4 "To Reset Push OFF/ON"

Conductivity Probe Error messages:

Line 2 "Inteference" - Noise detected by conductivity circuit, valid measurement not possible.

Line 2 "Over-range" - Measurement is out of range for the circuit, probe may also be shorted

Line 2 "Probe shorted" - Short circuit detected on temperature sensor in probe

Line 2 "Probe not detected" - Open circuit detected on temperature sensor in probe (white and un-shielded wire)

Line 2 "Probe Startup 1" - Internal reference voltage too high to make valid measurement

Line 2 "Probe Startup 2" - Internal reference voltage too low to make valid measurement

Line 2 "Probe Startup 3" - Internal excitation voltage too high to make valid measurement

Line 2 "Probe Startup 4" - Internal excitation voltage too low to make valid measurement

Appendix B. Controller Programming: Programming Interface Overview

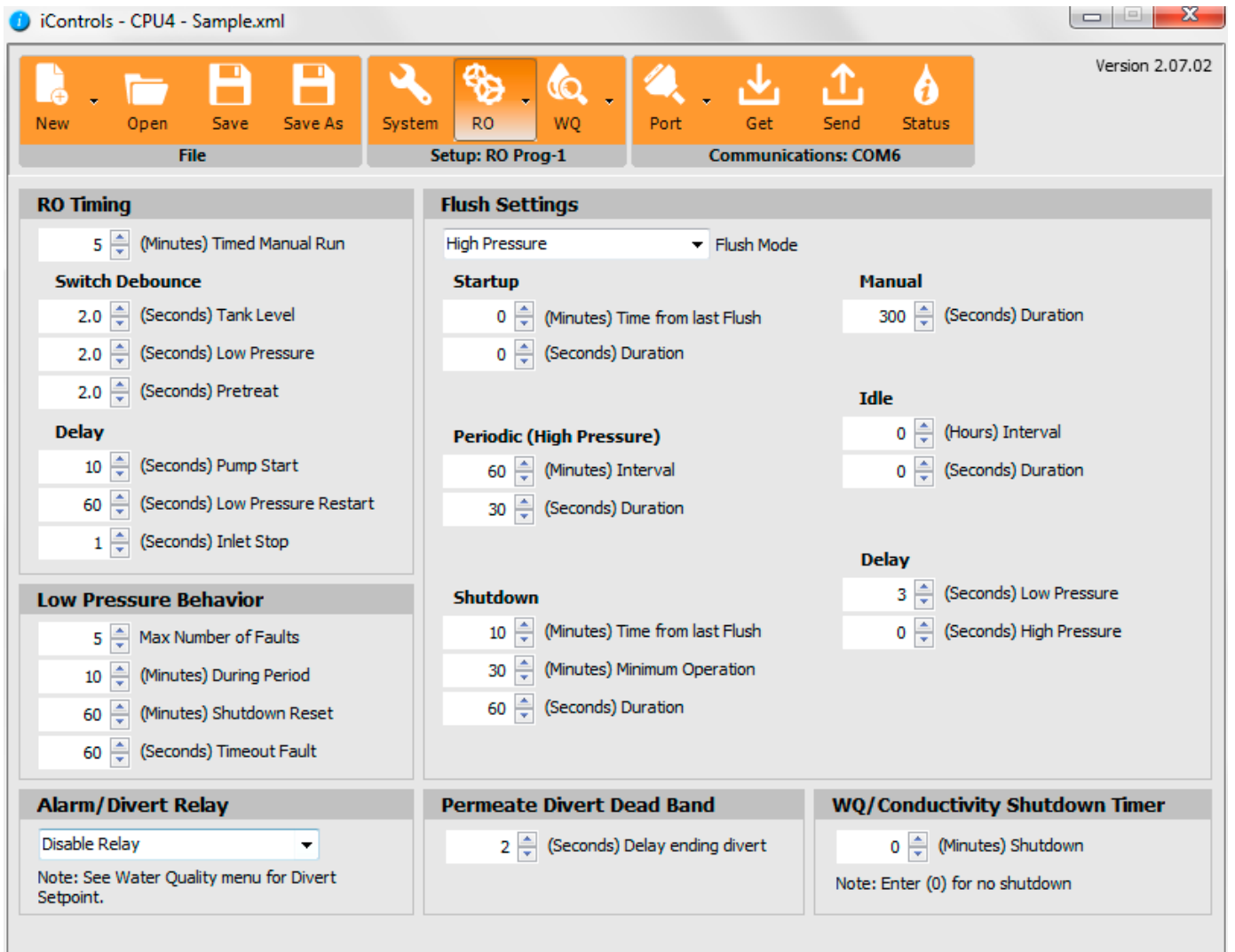

The Programming interface is a Windows-based tool for making changes to the ROC software. This screen shows the RO settings available. There are 4 field-selectable sets of settings stored in the CPU-.4

Appendix C. Warranty

iControls Limited Warranty

What the warranty covers:

iControls warrants the ROC 2HE to be free from defects in materials and workmanship during the warranty period. If a product proves to be defective during the warranty period, *iControls* will at its sole option repair or replace the product with a like product. Replacement product or parts may include remanufactured or refurbished parts or components.

How long the warranty is effective:

The ROC 2HE is warranted for one (1) year for parts and labor from the date of the first consumer purchase or 15 months from ship date, whichever comes first.

What the warranty does not cover:

1. Damage, deterioration or malfunction resulting from:
 - a. Accident, misuse, neglect, fire, water, lightning or other acts of nature, unauthorized product modification or failure to follow instructions supplied with the product.
 - b. Repair or attempted repair by anyone not authorized by *iControls*.
 - c. Any damage of the product due to shipment.
 - d. Causes external to the product such as electric power fluctuations.
 - e. Use of supplies or parts not meeting *iControls*' specifications.
 - f. Normal wear and tear.
 - g. Any other cause which does not relate to a product defect.
2. Transportation costs necessary to obtain service under this warranty.
3. Labor other than factory labor.

How to get service:

1. To obtain warranty service, contact *iControls* for a Return Material Authorization (RMA).
2. You will be required to provide:
 - a. Your name and address
 - b. A description of the problem
3. Package the controller carefully for shipment and return it to *iControls*, freight prepaid.

Limitation of implied warranties:

There are no warranties, expressed or implied, which extend beyond the description contained herein including the implied warranty of merchantability and fitness for a particular purpose.

Exclusion of damages:

iControls' liability is limited to the cost of repair or replacement of the product. *iControls* shall not be liable for:

1. Damage to other property caused by any defects in the product, damages based upon inconvenience, loss of use of the product, loss of time, loss of profits, loss of business opportunity, loss of goodwill, interference with business relationships or other commercial loss, even if advised of the possibility of such damages.
2. Any other damages, whether incidental, consequential or otherwise.
3. Any claim against the customer by any other party.

Effect of state law:

This warranty gives you specific legal rights, and you may also have other rights which vary from state to state. Some states do not allow limitations on implied warranties and/or do not allow the exclusion of incidental or consequential damages, so the above limitations and exclusions may not apply to you.