

SECTION A-A

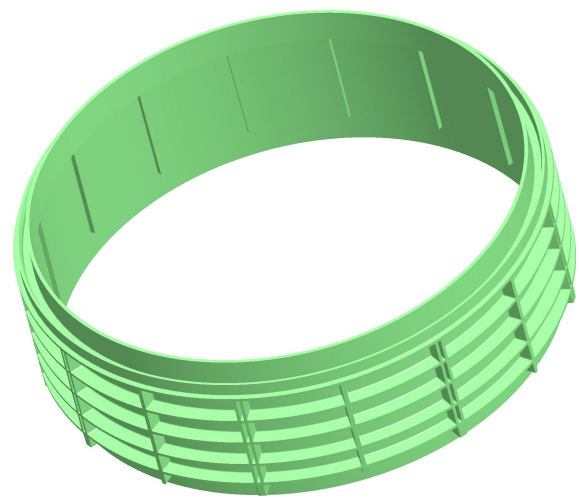

Material: Copolymer Polypropylene  
Color: Green

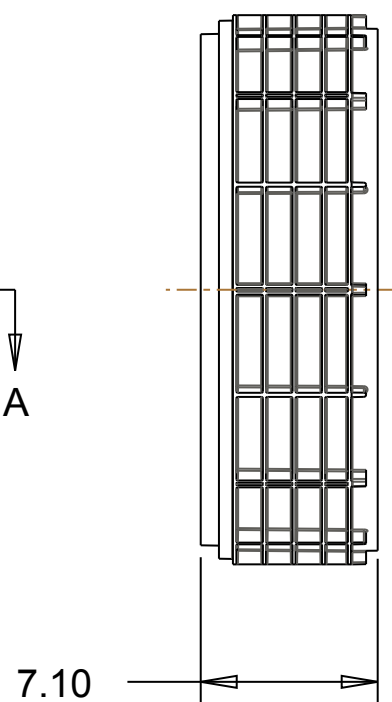
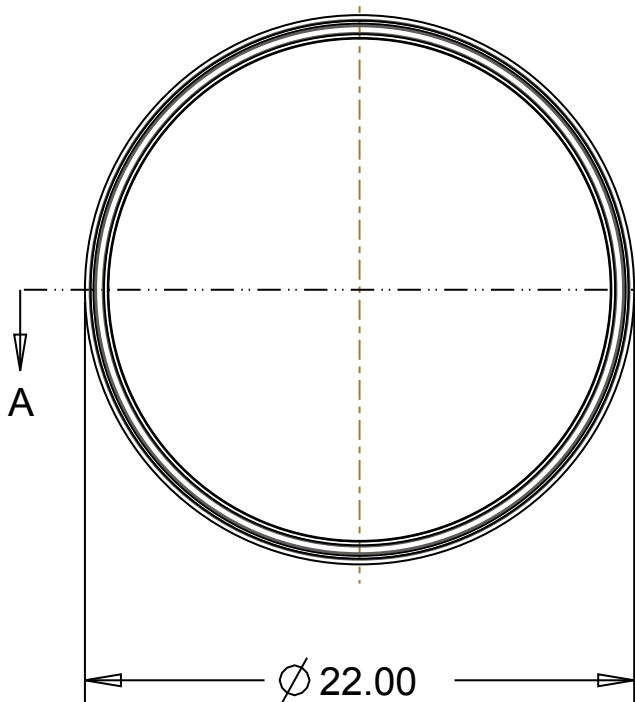
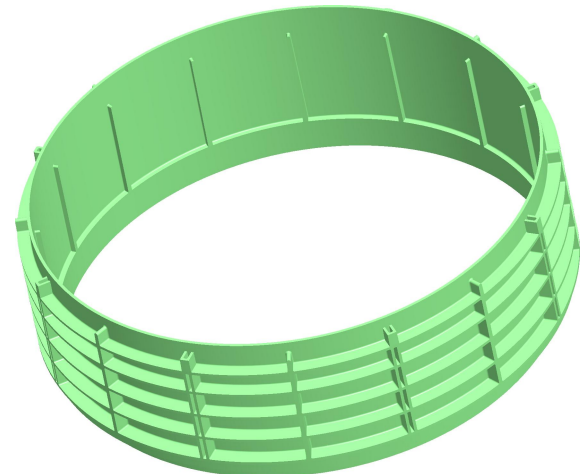

**Drainage and Septic Products**

Tuf-Tite, Inc.  
1200 Flex Court  
Lake Zurich, Illinois 60047

TELEPHONE: 847.550.1011  
TOLL FREE: 800.382.7009  
FAX: 847.550.8004

**PART NAME:**  
20" DIA. X 6" HIGH ROUND RISER

**PART #:** 20-RIS-GREEN