

Notice to Installer: Instructions must remain with installation.

SW0576
0310
Supersedes
0110

Product information presented here reflects conditions at time of publication. Consult factory regarding discrepancies or inconsistencies.

Quality Products Since 1866!

MAIL TO: 95 North Oak Street • Kendallville, IN 46755
(260) 347-1600 • 1 (800) 345-9422 • FAX (260) 347-0909

INSTALLATION INSTRUCTIONS

These installation instructions are applicable for
Residential Reverse Osmosis System
Model S07RO / P07RO

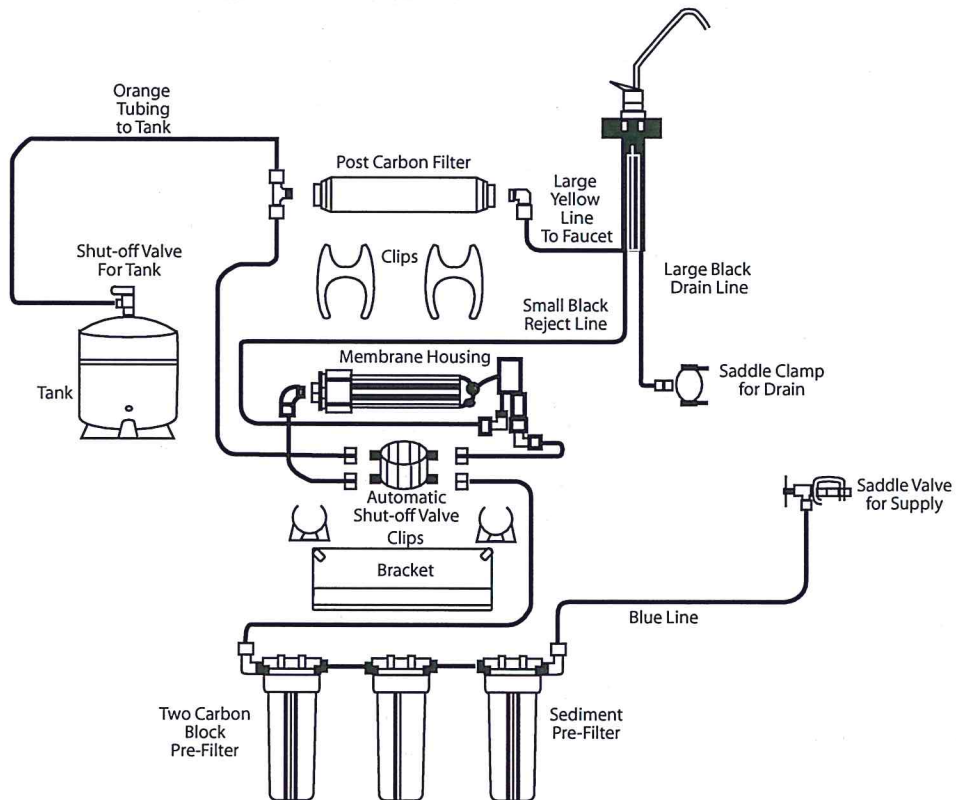
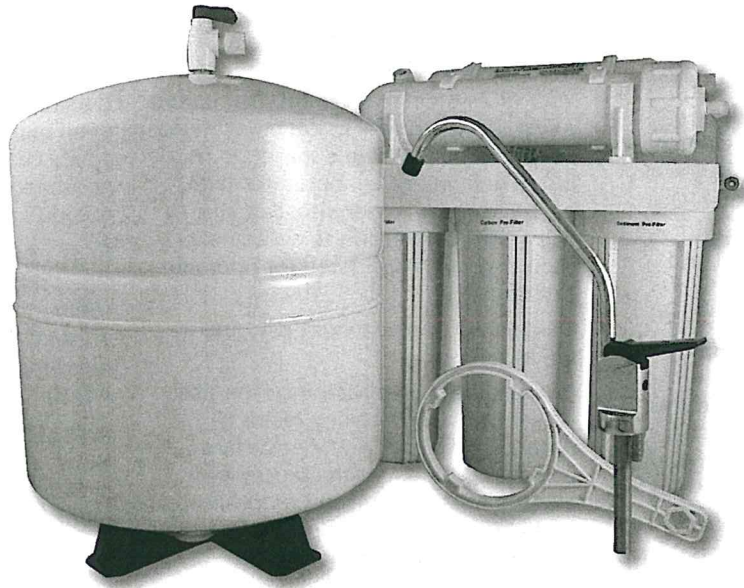

Your Reverse Osmosis System has been tested to ensure it will operate correctly. The following periodic maintenance is recommended so your system will provide years of trouble-free service:

REPLACEMENT PARTS	REPLACEMENT SCHEDULE
Pre-filter (sediment)	Every 6 mos.
Pre-filters (activated carbon)	Every 6 mos.
R/O membrane	Every 2-3 years
Post filter (carbon)	Every 6 mos.

COMPONENTS

The following components make up your Reverse Osmosis Drinking Water System:

Pre-filter (sediment) removes larger particles such as sand, silt, rust and scale.

Pre-filters (activated carbon) remove chlorine in the feed water to protect the reverse osmosis membrane.

Reverse Osmosis Membrane reduces dissolved minerals, metals and salts. During the process, harmful compounds are separated by the membrane and the reject water goes to waste (drain).

An activated carbon **post-filter** is provided for a final "polish" and to remove foul tastes, odors and to provide great tasting drinking water.

Filter housings and R/O module hold pre-filters and membranes. A bracket is provided so they may be mounted, typically below sink.

Storage tank holds filtered water, ready for use.

Automatic shut-off valve senses when the storage tank is full and closes the water supply to conserve water.

The dedicated **faucet** is used to dispense RO produced water when needed.

Feed water saddle valve is connected to the cold water line to supply water to the R/O system.

Waste water saddle valve is connected to the drain to remove reject water from the R/O system.

Tubing supplies feed and reject water.

Fittings are used for necessary hose connections.

TOOLS

The following tools may be necessary, depending on each particular installation:

- 3/8" variable speed electric drill, 1/8" & 1/2" bits
- 1-1/4" porcelain hole cutter (if hole for second faucet is not provided)
- Center punch and hammer
- 1-1/4" wood bit
- Concrete drill bits
- Phillips head and flat blade screwdrivers
- Adjustable wrench
- Teflon tape
- Plastic tube cutter
- Air pressure gauge (low pressure)
- Air pump (hand)

SYSTEM LOCATION

Your R/O system may be installed under a sink, in a basement or other location, depending on available space. Do not install unit where temperatures fall below freezing; otherwise, damage will result. Connection to an icemaker should also be considered for optimum performance.

Guidelines for component placement are as follows:

Faucet should be placed near the sink where drinking / cooking water is normally required. A 2" flat surface is required to mount the faucet if an existing hole for a second faucet is not available. The thickness of the mounting thickness should not exceed 1-1/4".

Storage tank may be placed where it is convenient, within ten feet of the faucet. Under the sink or in a nearby cabinet are excellent choices. If tank is located further than 10 feet from the faucet, use 1/2" tubing to reduce pressure drop. Full tanks may weigh more than thirty pounds, so a sturdy shelf is required.

R/O unit may be mounted on either side of the sink, in a cabinet or heated basement, with nearby access to a potable, cold water line.

Feed water connection is accomplished with a self-piercing feed water saddle valve. Locate this assembly as close to the R/O unit as possible. Connect to a potable, cold water supply line only.

Note: Softened water is preferred since it will extend the life of your R/O membrane.

Drain connection is accomplished using a waste water saddle valve which is designed to fit around a standard 1-1/2" OD drain pipe. The drain saddle valve should always be installed above (before) the tap and on the vertical or horizontal tailpiece.

Do not install the drain saddle valve near a garbage disposal; otherwise, plugging of the waste water line may occur. If discharging into a utility sink or standpipe, an air gap must be provided (Air gaps must be 1" or greater above the floor rim.)

Note: Plumbing codes may require the use of air gaps. Please check with your local municipality.

Do not connect the R/O system drain line to the dishwasher drain line due to the fact that back pressures may cause the air gap to overflow.

SITE PREPARATION

If a basement installation is advisable, check area to determine if extra fittings or hose are required. Upon arrival, it is a good idea to check the condition of all plumbing for potential leaks and advise customer so there will be no misunderstandings in the event leaks occur.

UNIT PREPARATION

Open shipping carton, remove components and check that all parts are present. Check empty storage tank to be sure air pressure is approximately 7 psi. Adjust if necessary.

INSTALLATION STEPS

Note: All plumbing must be completed in accordance with state and local plumbing codes. Some municipalities may require installation by a licensed plumber. Check local authority prior to installation.

1. Faucet installation

If the sink has a sprayer, it may be disconnected for faucet installation. A pipe cap or plug will be necessary to seal the sprayer connection.

To make the faucet mounting hole (if sprayer or second hole is not used), check below to make sure the drill does not interfere with anything below. Center punch in a small indent at the desired faucet location. (2" flat surface is required, not exceeding 1-1/4" in thickness.) Drill the required pilot hole of the chassis punch and tighten nut to cut the desired hole size. Clean up sharp edges.

The faucet should be positioned so it empties into the sink and spout swivels freely for convenience. If sink has a hole that can accommodate the RO faucet, no drilling is required. Proceed with mounting the faucet.

Porcelain, Enamel, Ceramic on Metal or Cast Iron Sinks:

Precautions must be taken to penetrate the porcelain through to the metal base and prevent it from chipping or scratching.

TOOLS REQUIRED:

- Variable speed drill
- Relton porcelain cutter tool set (7/8" or alternative size, 9/16")
- Plumber's putty

PROCEDURES:

1. Mark the center for the 7/8" hole
2. Form shallow putty around hole area and fill with enough water to lubricate carbide drill bit.
3. Carefully drill pilot hole through all layers. (Use light pressure and slow speed.)
4. Insert pilot tip of spring-loaded porcelain cutter into pilot hole.
5. Drill porcelain / enamel using spring loaded porcelain cutter, making certain a complete ring has been cut through the porcelain / enamel to the metal base.
6. Cut away the inner porcelain / enamel disc down to the base metal. Make certain the cutter does not touch outer rim of the cut porcelain / enamel. Continue with this bit to cut through metal until sink has been completely penetrated.

Note: Always use sharpened porcelain cutter to eliminate chips and cracks.

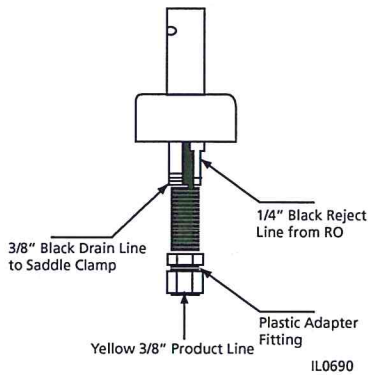

Faucet Installation with Airgap

Installation procedures for stainless steel sinks

Recommended tools:

- Center punch
- Variable speed drill
- High speed drill bits
- Greenlee chassis punch 7/8" (or 9/16" for non air gap faucets)

- Protective gloves & eye protectors

PROCEDURES:

- A. Center punch small indent for hole.
- B. Drill the required pilot hole.
- C. Set-up the chassis punch per instructions and tighten nut to cut the desired hole size.
- D. Clean up sharp edges with file.

2. Mounting the faucet

Disassemble hardware from the threaded nipple, except for chrome base plates and rubber washers. (Rubber washers may be replaced with bead of plumber's putty for neater appearance.) Feed the threaded nipple through sink or counter mounting hole and orient the faucet. From below sink or counter, assemble the white spacer flat washer and hex nut on threaded nipple and tighten by hand. (Open end up; open side toward air gap). After checking faucet orientation, tighten with a wrench until secure.

3. Feed water valve and tubing installation

The saddle tapping valve which is supplied is designed for use with 3/8" to 1/2" OD soft copper supply tubing (plain or chromed) and rigid metal pipe. Do not use with flexible ribbed supply tubing which is too thin and requires special hardware.

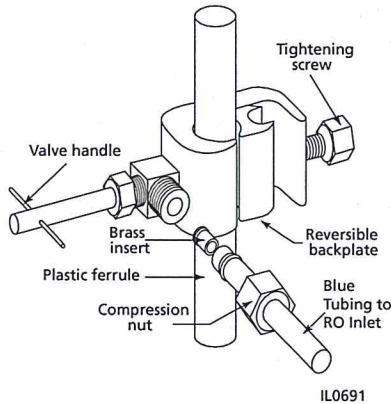

Self-tapping feed water saddle valve installation

Installation procedures using soft copper tubing:

1. Turn off cold water valve from under sink or main water line valve for whole house.
2. Before installing saddle tapping valve, make sure piercing lance does not protrude beyond rubber gasket.
3. Assemble saddle valve on copper tubing.
4. Turn handle clockwise to pierce soft copper tube until valve is

95 North Oak Street Kendallville, IN 46755

firmly seated. (Valve is closed in this position.)

5. Turn on water supply to pressure cold water line.
6. Snug nut/seal with wrench around valve stem.
7. Connect tubing to feed water valve using brass compression nut, insert and plastic sleeve.

Saddle valve installations with metal pipe:

1. Turn off cold water supply.
2. Drill 3/16" hole at desired location.
3. At this point, make sure piercing lance does not protrude beyond rubber gasket.
4. Assemble saddle on to pipe, aligning with hole.
5. Turn saddle valve handle clockwise to close valve.
6. Tighten nut/seal around valve stem with wrench.
7. Connect tubing to feed water valve using brass compression nut, insert and plastic sleeve.
8. Turn on cold water supply.
9. To open valve, turn handle counterclockwise and check for leaks.

4. Drain saddle valve installation

Prior to proceeding it is important to inspect the condition of drain pipes to make sure they are not thin and frail.

Drain saddle valves are designed to be installed on standard 1-1/2" OD drain pipe. Install drain saddle valve above (and before) the trap and on the vertical or horizontal tailpiece. Never install a drain saddle valve close to the outlet of a garbage disposal or plugging of the RO drain line may result.

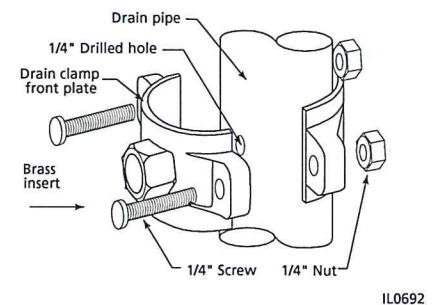

Drain saddle valve installation

Procedures

1. Position threaded half of drain saddle valve at selected location and mark for the opening.

2. Drill 1/4" hole at mark through one side of pipe.
3. Position both halves of drain saddle on drain pipe so threaded opening lines with hole.
4. Secure drain saddle clamp on valve with bolts and nuts provided. (Do not over tighten and make sure there is equal space between saddle halves on each side.)

5. Initial tubing connections

For convenience on under counter installations it may be advisable to complete under counter hose connections at this time.

6. RO component installation

Install RO membrane, carbon pre filter and sediment pre filter in modules of RO unit. (Refer to RO installation diagram.)

7. RO unit installation

The RO unit is normally mounted to the right or left sink cabinet sidewall, depending on where supply tank is to be located. Generally the unit is installed at the front of the cabinet and the tank at the rear.

To mount the unit, elevate it at least 2" off the floor, level it and mark the location of mounting holes needed. Drill holes for mounting screws and install screws, allowing the mounting bracket slots to slip over them.

Note: If the cabinet sidewalls are not solid, unit may sit on the floor with screws to keep it against the cabinet in a vertical position.

8. Pre-fill, sanitizing and supply tank placement

Prefilling the storage tank is always recommended so there is sufficient pressure to check for leaks and sufficient water to flush the carbon post filter.

It is important to use a sanitizer (such as Clorox) so tubing, fittings, tank and the faucet will be safe to use upon start-up.

To pre-fill storage tank follow these directions:

1. Connect storage tank to feed water line.
2. Open feed water valve and valve on tank.
3. Allow to fill for approximately three minutes.
4. Turn off feed water valve and tank valve.
5. Do not flush tank for approximately 15 minutes.

The supply tank should be placed under the counter or within 10 feet of the RO unit.

Note: Tanks are pre-pressurized at 7 psi. Prior to installation, check, add or release as required.

9. Final tubing connections

With all components in place, complete final tubing connections using these guidelines:

- Tubing should follow contour of the cabinets.
- Cut tubing to desired length using square cuts and proper cutting device.
- Make no sharp bends.
- Keep tubing from the RO unit to the tank and faucet as short as practical for good flow.

Under sink installations following installation diagram and the following procedures:

1. Connect yellow tubing from faucet to RO unit.
2. Connect orange tubing from tank to RO unit.
3. Connect blue tubing from supply valve to RO unit.
4. Connect black tubing from drain valve to RO unit.

ICEMAKER HOOKUP (OPTIONAL)

The RO drinking water device can be connected to any standard refrigerator ice maker or ice maker / water dispenser. (Do not connect to a commercial type bar ice maker.)

To complete this operation, connect a tee with shutoff valve into the yellow faucet tubing and route tubing to the refrigerator. (Hooking up to an existing copper line is not recommended unless it is new installation.) Shut off ice maker by lifting lever prior to turning off the existing tap water supply line to the refrigerator. Turn on ice maker after the RO system has been drained several times and the tank has a full supply of water.

Note: Before any service is performed on the RO system, turn off ice maker valve and ice maker unit. Turn back only after RO tank is full.

SYSTEM START-UP

Prior to start-up

1. Check all connections be sure they are secure.
2. Turn on feed water valve and check for leaks. (Turn off and correct leaks if leaks occur.)
3. Open valve on storage tank and open faucet until a steady stream of water flows.
4. Close faucet and wait five minutes to see if leaks result.

Note: When the system is first turned on, water may intermittently "spurt" from the air gap opening on the side of air gap faucets. This is common and should correct itself after an initial period of time.

FLUSHING SYSTEM AND CHECKING OPERATION

To make sure RO system is operating correctly, following these simple procedures:

1. Open faucet handle and allow tank to completely drain of sanitizing solution. **Do not use this water.**
Note: When tank is empty, faucet will steadily drip. This is the rate the RO system processes water.
2. With faucet handle in "open" position, measure the rate of the steady drip from spout. Use a graduated cylinder and watch with a second hand to calculate approximate production in gallons per day.

Note:

Milliliters per minute X 0.38 = GPD.

Ounces per minute X 11.2 = GPD

3. Proceed to check reject flow rate by disconnecting tubing at drain connection and measure flow as described above.
- Note: Proper ratio should be 3 reject water to 1 part of product water, on average.
4. Close faucet and re-inspect system for leaks.
5. Allow system to process water for approximately four hours, at which point tank will be practically full.
6. Open faucet again and allow tank to empty for a second time.

Do not use this water.

7. Wait another four hours to allow tank to refill.
- Note: If no objectionable tastes are noticed after second tank draining, RO processed water is ready for use. Otherwise, drain tank and re-fill for a third time.
8. At this point supply line to ice maker connection (optional) may be opened.

MAINTENANCE

Your RO system contains filters and membranes which must be replaced periodically for proper operation. (Please see page 1 for general changeout recommendations.)

Note: Change-out procedures may be amended, depending on source water conditions.

To change filters and membranes follow these procedures:

1. Close feed water valve by turning it clockwise.
2. Open faucet to allow holding tank to drain.
3. Loosen and remove filter housings using wrench provided and discard cartridges and or membrane.
4. Wash the inside of the housings using mild detergent and soft cloth. Thoroughly rinse all soap before reassembly.
5. Replace filter cartridges and membrane before sanitizing system.

Note: The system should be sanitized before installing the activated carbon post filter cartridge.

SANITIZING INSTRUCTIONS

To sanitize system follow these procedures with the feed water valve closed:

1. Remove pre-filters and membrane from housings.
2. Use 5-1/4% unscented bleach such as Clorox.
3. Add one cap full (2 tsp or 10 ml) of bleach to each pre-filter housing and membrane module.
4. Carefully refill housings with tap water and temporarily replace without carbon cartridge, sediment cartridge or membrane installed.
5. Slowly open the feed water line at faucet.
6. Close faucet as soon as water begins to drip out of spout.
7. Let system stand for approximately 15 minutes.
8. After fifteen minutes do the following in order:
 - Close feed water valve.
 - Close holding tank valve while faucet is open to release pressure.
9. Remove housings and empty them.
10. Remove any protective wrap from pre-filters and membrane and install them in the appropriate filter housings. Tighten with wrench.
11. Replace post carbon filter if necessary.

Note: Be sure to check o-rings are in place when installing cartridges in filter housings.

12. Disconnect product water tubing from the holding tank and put 50 drops of bleach into the tubing. Reconnect tubing.
13. Slowly open feed water saddle valve. When water begins to drip from faucet, close faucet and open holding tank valve.

14. Do not open faucet for at least eight (8) hours.
15. Discard the first two tanks of water produced, as they contain chlorine. Do not use this water.
16. When faucet is first opened, air and black carbon powder may be noticed. This is normal.

WATER QUALITY

Water quality from an RO system is normally determined with a TDS Meter, which measures total dissolved solids in water, measuring conductivity. The results are normally measured in parts per million or milligrams per liter. Fewer dissolved solids result in higher quality water.

RO membranes are rated by the amount of dissolved solids they reject, expressed as "rejection" percentage". For example if feed water contains 100 ppm of dissolved solids and the product water after the membrane has 10 ppm of dissolved solids the rejection rate is 90%. The formula is as follows:

$$\text{Percent rejection} = \frac{\text{Feed water TDS} - \text{Product water TDS} \times 100\%}{\text{Feed water TDS}}$$

WATER PRODUCTION

Product water rate

Usable water production from an RO system is designated product water rate, produced on a daily basis. The rate is normally described in gallons per day (gpd) or milliliters per minute (ml/min.).

Reject water rate

The flow of water to drain is designated as reject water rate, as measured in gallons per day (gpd) or milliliters per minute (ml/min.).

Using a graduated cylinder the formulas are:

$$\begin{aligned} \text{Milliliters per minute} \times 0.38 &= \text{gallons per day} \\ \text{Ounces per minute} \times 11.2 &= \text{gallons per day} \end{aligned}$$

Reject ratio

The reject ratio is the amount of water produced compared to the amount of water flowing to drain.

The formula is as follows:

$$\text{Reject ratio} = \frac{\text{Reject rate}}{\text{Product rate}}$$

Percent recovery

The percent recovery is another way to measure the amount of water produced compared to the amount of water which is actually used.

The formula to determine percent recovery is as follows:

$$\text{Percent recovery} = \frac{\text{Product water rate} \times 100\%}{\text{Feed water rate}}$$

Note: Product water rate is the sum of the feed water flow rate and reject water flow rate.

Example:

Product water rate = 10 gpd

Reject water rate = 40 gpd

Feed water = 10 gpd + 40 gpd or 50 gpd

Percent recovery = 20%

WATER PRESSURE AND TEMPERATURE

Product water quality and production of RO systems is dependent on pressure and temperature. Typically, RO membranes are treated at standard conditions of 77° F (25° C) and 60 psi (4 bar) discharging to atmosphere. In general, the higher the pressure differential and temperature, increased quality and quantity of water is produced.

These factors should be considered when sizing RO systems for a particular application.

JOHN GUEST® BRAND FITTINGS

This RO system utilize John Guest brand fittings. These user - friendly fittings provide superior performance and may be provided with this system. Proper use of these push-in fittings is shown below. Along with these fittings, all tubing selected must be of high quality and must be cut with a plastic tube cutter or sharp razor with a clean, square cut.

Should a leak occur at a fitting, the cause is generally defective tubing. To fix a leak, relieve pressure, release tubing, cut off at least 1/4" from the end (square cut), reattach the tubing and confirm the connection is leak free. Each time a new connection is made, it is advisable to cut off 1/4" from the end of the tubing using these fittings.

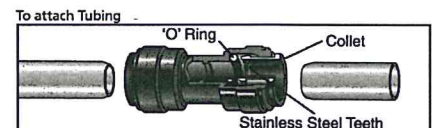

Cut the tube square and push into the tube stop. For metal tube, remove burrs and chamfer tube end to prevent the "O" ring seal from being damaged. For soft or thin walled plastic tubing, the use of a tube insert is recommended.

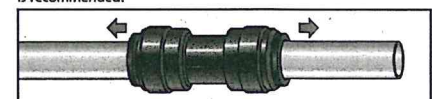

Pull the tube to check that it is secure. It is a good practice to check the system before use.

IL0700

CONVENTIONAL COMPRESSION FITTINGS

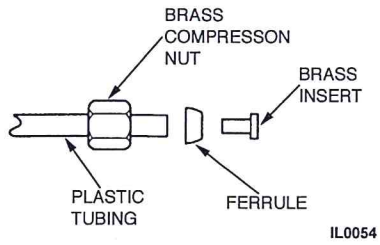

It is essential to install inserts at the ends of all tube connections when conventional fittings are used.

**REPAIR PARTS FOR
MODEL S07RO / P07RO
Residential Reverse Osmosis Systems**

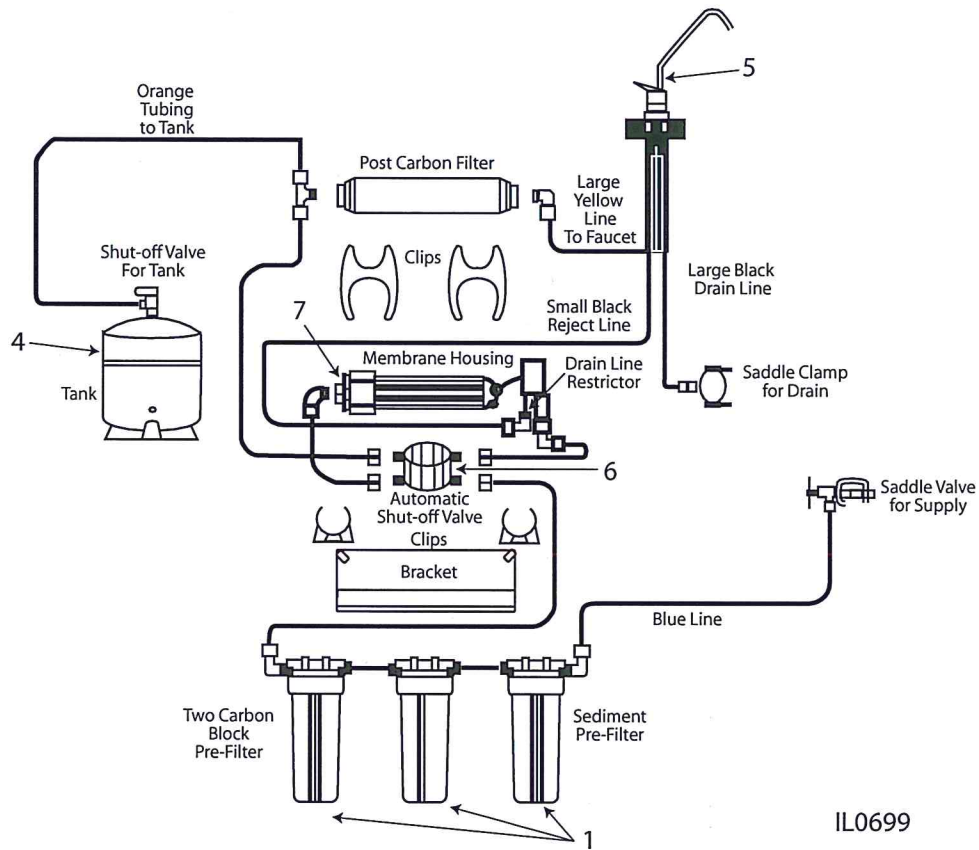

IL0699

No.	Part Number	Description
1	022471	Filter sumps
2	KH89*	Kit includes membrane and post-carbon filter
3	KH90*	Kit includes sediment pre-filter and two carbon block pre-filter cartridges
4	136830	Storage tank, metal with PE lining
5	136579	Faucet, low lead, air gap
6	022473	Automatic shut off valve / 1/8" NPT thread
6	023387	Automatic shut off valve / quick connect
7	022475	Membrane housing (end, side, side)
8	022477*	O-ring Filter Sump
9	022476*	O-Ring Membrane Housing
10	023316	Drain Line Restrictor

*Not Shown

SYMPTOM	POSSIBLE CAUSE(S)	CORRECTIVE ACTION
NO WATER	<ol style="list-style-type: none"> 1. Tank improperly pressurized 2. Water supply turned off 3. Low water pressure (40 PSI min.) 4. Pre-filter clogged 5. Module damaged or clogged 6. Product line crimped 7. Post-filter clogged 8. Ball valve closed on storage tank 9. Check valve/restrictor valve clogged 	<ol style="list-style-type: none"> 1. Set tank pressure at 5 - 7 PSI when empty 2. Turn on 3. Call dealer for assistance 4. Replace 5. Replace 6. Remove crimp 7. Replace 8. Move valve to up position 9. Replace
SLOW FLOW THROUGH FAUCET	<ol style="list-style-type: none"> 1. Post-filter clogged 2. Low air in holding tank 3. Pre-filter clogged 4. Low water pressure (40 PSI min.) 5. Check valve/restrictor valve clogged 	<ol style="list-style-type: none"> 1. Replace 2. Raise pressure to 5-7 PSI when empty 3. Replace 4. Call dealer for assistance 5. Replace
LEAKING MODULE HOUSING	<ol style="list-style-type: none"> 1. Threaded end cap leak 2. Compression fitting leak 3. Leak at screw cap 	<ol style="list-style-type: none"> 1. Lube o-ring and tighten 2. Tighten, apply Teflon tape, or replace 3. Replace o-ring if damaged
LEAKING POST-FILTER	<ol style="list-style-type: none"> 1. Leak at compression fitting 2. Leak at post-filter seam 	<ol style="list-style-type: none"> 1. Tighten, apply Teflon tape, or replace 2. Replace
LEAKING FAUCET	<ol style="list-style-type: none"> 1. Fitting leak 2. Leak at base or brass barbs 3. Faucet drips 4. Overflow at air gap 	<ol style="list-style-type: none"> 1. Tighten or replace 2. Replace faucet 3. Install faucet repair kit 4. Shorten 3/8" line from faucet to drain connection. Clean 3/8" line from faucet to drain connection
BAD TASTE	<ol style="list-style-type: none"> 1. Defective membrane 2. Restriction in waste flow 3. Carbon post-filter 4. Growth in tank 5. Low water pressure (40 PSI Min.) 6. Check valve/restrictor clogged 	<ol style="list-style-type: none"> 1. Replace 2. Clear 3. Replace 4. Sanitize 5. Call dealer for assistance 6. Replace