

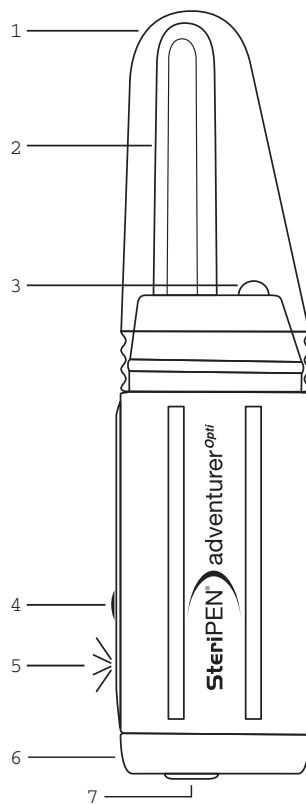

## See Water in a Whole New Light

SteriPEN® Adventurer<sup>Opti</sup> User's Guide



### Guide to SteriPEN® Adventurer<sup>Opti</sup>

- 1) UV Lamp Cover
- 2) UV Lamp Assembly
- 3) Optical water sensor
- 4) Activation Button
- 5) Indicator LED (Light Emitting Diode): shows activation status
- 6) Battery Compartment End Cap
- 7) Battery Compartment End Cap Screw

Thank you for buying your SteriPEN® Adventurer<sup>Opti</sup> and congratulations on your purchase. Years of careful research, development and testing have gone into the creation of this unique product.

**Directions for Use** 40 C.F.R. §156.10(i)(2)  
*It is a violation of Federal law to use this product in a manner inconsistent with its labeling.* 40 C.F.R. §156.10(i)(2)(ii)

SteriPEN® exceeds U.S. EPA Guide Standard and Protocol for Testing Microbiological Water Purifiers, destroying over 99.9999% of bacteria, 99.99% of viruses, and 99.9% of protozoa when used as directed. SteriPEN® is not a sterilizer.

## Operating the SteriPEN® Adventurer<sup>Opti</sup>

### Quick Start Guide

Use SteriPEN® Adventurer<sup>Opti</sup> with clear water. Discolored or dirty water should be pre-filtered until clear prior to SteriPEN® Adventurer<sup>Opti</sup> treatment. See also "Treating Turbid, Murky, or Cloudy Water"

**SteriPEN® Adventurer<sup>Opti</sup> treats two ranges of water volume:**

- A**—up to 0.5 liter (16 fl. oz.)
- B**—between 0.5 – 1.0 liter (16 and 32 fl. oz.)

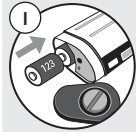

**1** Install two CR123 batteries with polarities as shown; or install one double-cell CR123 battery.

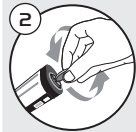

**2** Tighten coin screw on battery end cap until snug (do NOT over-tighten screw as this may cause damage).

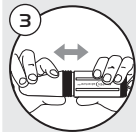

**3** Remove lamp cover – pull cover off body.



**4A** Push Activation button **twice** – green indicator LED (near button) and white optical sensor (near lamp) will flash for up to 15 seconds indicating Adventurer<sup>Opti</sup> is ready to treat up to .5 liter (16 fl. oz.).

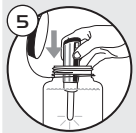

**4B** Push Activation button **once** – green indicator LED (near button) and white optical sensor (near lamp) will flash for up to 15 seconds indicating Adventurer<sup>Opti</sup> is ready to treat up to 1 liter (32 fl. oz.).

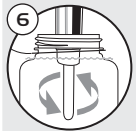

**5** While green indicator LED and white optical sensor flashes, dip the ultraviolet (UV) lamp into the water to be treated such that lamp and optical sensor are completely immersed. When water is detected, lamp turns on automatically, emitting both UV and visible light. **IMPORTANT NOTE:** If visible light from UV lamp is not evident, the Adventurer<sup>Opti</sup> UV lamp is not on, and water should not be consumed.



**6** Agitate the water throughout the dose by stirring with the Adventurer<sup>Opti</sup> until the lamp automatically turns off. Once lamp turns off, green indicator LED will turn on to show that the UV dose is complete. **NOTE:** If red LED turns on after lamp shuts off, the dose was not complete.

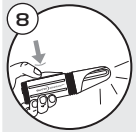

**7** Remove Adventurer<sup>Opti</sup> from water. Dry off lamp and optical water sensor with clean cloth. **IMPORTANT NOTE:** Many brands of CR123 batteries have built-in protection circuitry that instantly disables battery function when batteries reach a specific low charge threshold. If this "disable" function is triggered during operation the Adventurer<sup>Opti</sup> will be unable to give the "Low Battery" signal (blinking red LED). Until batteries are replaced or recharged the Adventurer<sup>Opti</sup> will not be operational.

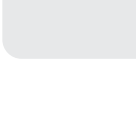

**8** To activate the flashlight, press and hold the activation button for 3 seconds. The flashlight will automatically be on for 3 minutes; reactivate as needed. To turn off the flashlight, push the activation button once. To protect UV lamp when using the flashlight, operate with lamp cover in place.

### Safety

SteriPEN® Adventurer<sup>Opti</sup> may be used in glass, plastic, ceramic or metal containers. They all absorb and reflect UV light, thereby shielding the user from UV exposure. Adventurer<sup>Opti</sup> should not be used in quartz containers. The air/water interface at the top of any drinking container is highly reflective to UV and reflects UV back into the container.

### Optical Water Sensor

SteriPEN® Adventurer<sup>Opti</sup> features an advanced proprietary optical water sensing technology. This is an important safety feature intended to prevent UV exposure by permitting operation only when lamp is completely immersed in water. Never attempt to bypass this feature. If the SteriPEN® Adventurer<sup>Opti</sup> does not detect water within 15 seconds of being activated, it will deactivate.

### Agitation of Water

Agitation of the water by stirring with Adventurer<sup>Opti</sup> or rocking the container throughout the dose is essential for proper operation as this insures uniform exposure of all water to germicidal UV light.

### Cold Weather Considerations

Bring Adventurer<sup>Opti</sup> up to a temperature above 32°F/0°C before using. Battery performance may be adversely affected by cold weather.

### SteriPEN® Adventurer<sup>Opti</sup> LED Signals

LED Color and Pattern Display	Indication
<b>Operating Signals</b>	
Green, fast flashing (after button push)	Unit is armed and ready to treat water
Green, slow flashing: 1 second on, 1 second off (after dose completion)	1 liter (32 fl. oz.) dose completed
Green, steady (after dose completion)	0.5 liters (16 fl. oz.) dose completed
Green blinks for 15 seconds followed by a quick Red flash	Time expired, try again. The user has 15 seconds to put the SteriPEN® in water after activation.
Green flash followed by Red flash	(1) Dry water sensing pins before use. (2) Press activation button for 1 second to activate for 32 oz. timer; again for 16 oz. (3) Clean water sensing pins.
Red, steady	Dose incomplete. Repeat treatment.
<b>Battery Warnings</b>	
Red, fast flashing	Low battery warning; replace or recharge batteries
Green slow blinking with Red flashes	1 liter (32 Fl. Oz.) dose completed; battery getting low
Green, steady with Red flashes	0.5 liter (16 Fl. Oz.) dose completed; battery getting low
Indicator LED will not come on	(1) Check battery orientation (2) Charge or replace batteries (3) Clean battery contacts (4) Return SteriPEN® for repair
<b>Lamp Warnings</b>	
Red 2 flashes, Green 2 flashes (repeating)	Over 7,900 treatments completed; lamp replacement needed in under 100 doses
Red 3 flashes, Green 1 flash (repeating)	Lamp failure; replace lamp
Normal indicator LED function, yet UV lamp emits no visible light	Lamp failure. Do not consume water. Follow warranty procedure.

### Lamp Life

After Lamp Life = 8,000 Treatments, lamps must be replaced by manufacturer or licensed technician.

### Battery Selection & Installation

SteriPEN® Adventurer<sup>Opti</sup> uses two CR123 batteries. CR123 batteries are nominally 3 volts and are available in both rechargeable and non-rechargeable (disposable) varieties. One double-cell CR123 battery may also be used.

Use high quality name brand batteries. Our testing has shown that a single set of non-rechargeable (disposable) CR123's will

treat approximately 50 liters of water. Testing on rechargeable CR123's (650mAh) indicates that approximately 30 liters may be treated between battery charges.

Cold ambient temperatures may reduce the number of doses available from batteries. To maximize available battery power keep your batteries in a warm place (i.e. your pocket) when in cold weather conditions.

To replace batteries, loosen screw in battery end cap with a coin and then remove end cap (*see diagram 2*). Install new or recharged batteries with battery polarity as shown—positive ends of batteries facing out, toward battery compartment end cap (*see diagram 1*). Replace the battery end cap and tighten screw until snug. Do not over tighten screw as this may damage the device.

Note that if you will be storing your SteriPEN® Adventurer<sup>Opti</sup> for a long period of time, it is best to remove the batteries from the device. As with all high-tech devices, the batteries must be removed when storing the unit. This will reduce/prevent battery terminal corrosion, spring fatigue and batteries from draining.

**IMPORTANT NOTE:** Many brands of CR123 batteries have built-in protection circuitry that instantly disables battery function when batteries reach a specific low charge threshold. If this “disable” function is triggered during operation the Adventurer<sup>Opti</sup> will be unable to give the “Low Battery” signal (blinking red LED). Until batteries are replaced or recharged the Adventurer<sup>Opti</sup> will not be operational.

### Treating Turbid, Murky or Cloudy Water

SteriPEN® Adventurer<sup>Opti</sup> is intended for use, and is most effective, in clear water. However, SteriPEN® has been shown to reduce microbial contamination in turbid water. If clear water is not available, first try to filter the water to clarify it. If it is necessary to treat turbid, murky or cloudy water in an emergency situation, use SteriPEN® as follows:

- To treat 1 liter of turbid water, use two one-liter treatments. To accomplish this, push the operating button one time and complete the first treatment. Then push the button one time again and complete the second treatment.
- To treat 0.5 liters of turbid water, use a single 1 liter dose. To accomplish this, push the operating button once and complete the treatment.

Turbidity is a measure of water clarity as effected by the presence of suspended solids. As turbidity increases, the suspended solids and murkiness of the water also increase. It is difficult to communicate a particular level of turbidity with just a written description. Accordingly, please take into account the following when considering the use of SteriPEN® in water that is not clear: Laboratory testing has shown that SteriPEN® is effective in water with a turbidity of not less than 30 ntu (Nephelometric Turbidity Units) as described in the U.S. EPA Guide Standard and Protocol for Testing Microbiological Water Purifiers, section 3.3.4. SteriPEN® has been successfully tested in water with a turbidity measurement of 33 ntu. If viewing 33 ntu water in a clear 1 liter bottle, one might characterize the water as follows: *Much closer to clear than opaque, Obviously not clear, Obviously cloudy, Objects viewed through the water are visible but blurry, As cloudy as weak lemonade.*

### Care and Cleaning

When not in use, Adventurer<sup>Opti</sup> should be kept in a clean, dry, non-abrasive area or container. Adventurer<sup>Opti</sup> should not be exposed to ambient temperatures above 140°F/60°C or below -4°F/-20°C. When storing Adventurer<sup>Opti</sup> for long periods, remove batteries.

To clean Adventurer<sup>Opti</sup>, wash with a soft cloth and a mild soap solution. Rinse soap from device and dry with a clean, soft cloth. Note that while the battery compartment of Adventurer<sup>Opti</sup> is designed to be water resistant, it is not guaranteed to be impermeable and should therefore never be submerged.

### Troubleshooting

If flashing green indicator LED (Light Emitting Diode) shows that Adventurer<sup>Opti</sup> is armed, but the lamp does not light when immersed in water, check to be sure UV lamp and optical sensor is completely immersed.

If fresh batteries have been installed, but low battery LED warning appears, low battery temperature may be the cause. Remove batteries from device and warm them (i.e. in your pocket).

If after initiating a dose UV lamp shuts off and indicator LED does not come on at all, the batteries may be drained and in need of replacement or charging. See **“IMPORTANT NOTE”** above.

### Repair Information

Any repairs to your Adventurer<sup>Opti</sup> should be done by an authorized technician. For repairs in the US, contact Hydro-Photon directly at [info@steripen.com](mailto:info@steripen.com) or 1-888-SteriPEN. Customers outside the US, please contact your local distributor/importer; this information is listed at [www.steripen.com](http://www.steripen.com). For additional troubleshooting and repair information, visit [www.steripen.com](http://www.steripen.com)

### Product Registration & Warranty Information

Limited Lifetime Warranty for any manufacturing defect. For product registration and complete warranty information, please visit [www.steripen.com/warranty](http://www.steripen.com/warranty) or contact your local distributor/importer.

### Warnings for Safe Use

- Improper operation of Adventurer<sup>Opti</sup> may cause injury. Read and understand all warnings prior to operating Adventurer<sup>Opti</sup>.
- As with any water treatment system, you should always have a backup method and an extra set of fresh batteries available.
- Do not allow water to enter Adventurer<sup>Opti</sup> through the battery compartment. While the battery compartment seal is designed to be water resistant, it is not guaranteed to be impermeable.
- Do not submerge the battery compartment end of the device.
- Do not operate Adventurer<sup>Opti</sup> in quartz containers such as quartz laboratory beakers.
- Adventurer<sup>Opti</sup> should not be used by children.
- Adventurer<sup>Opti</sup> is a high voltage device. Removal or tampering with the electronic circuit board or lamp assembly may cause personal injury, or damage Adventurer<sup>Opti</sup>.
- Do not open, expose, modify or touch internal circuitry; this can lead to high voltage shock.
- Do not attempt to bypass optical sensor: this is an important safety feature.
- Like most fluorescent-type lamps, the Adventurer<sup>Opti</sup> lamp contains a small amount of mercury. Please return your Adventurer<sup>Opti</sup> at the end of its productive life to your distributor/importer to permit correct recycling or safe disposal.
- Adventurer<sup>Opti</sup> is not intended to disinfect surfaces of a drinking container, i.e. those that typically contact the mouth when drinking. Be certain that your drinking container has been properly cleaned/washed prior to using Adventurer<sup>Opti</sup>.
- Adventurer<sup>Opti</sup> is not intended to disinfect water above the surface of the water in the container, i.e., droplets of water suspended on the side of the glass.

- AdventurerOpti is intended for use with clear water but in emergencies may be used in moderately turbid water. See "Treating Turbid, Murky or Cloudy Water" section above before deciding to use SteriPEN® on turbid water.
- AdventurerOpti is designed to treat 0.5 or 1.0 liter (16 or 32 fl. oz.) of clear water. If in doubt about volume of water to be treated, confirm volume with a measuring device such as a measuring cup.
- Do not store AdventurerOpti for long periods with batteries installed. Batteries may in rare instances leak or corrode and cause damage to device.
- When operating properly, the AdventurerOpti's UV lamp will emit visible light as well as UV. If UV lamp is not emitting visible light, it is not functioning properly, and should not be used until repaired.
- The AdventurerOpti lamp assembly must be clean prior to use.
- If AdventurerOpti is below 32°F/0°C it should be warmed above 32°F/0°C before operating.
- Do not allow impact to the lamp end. If lamp assembly (lamp or quartz sleeve) is cracked, chipped or damaged, do not operate. Return to your local distributor/importer for repair.
- Do not use in liquids other than clear water.
- Do not use in water with ice.
- Do not use in water above 140°F/60°C.
- UV light can be harmful to eyes and skin. Never look at an unshielded UV lamp during operation.
- Do not operate near skin.
- Do not operate near eyes.
- Do not insert into bodily orifices.
- While carefully controlled microbiological testing has been conducted, use of AdventurerOpti in non-laboratory conditions may produce results that vary from our laboratory test data.
- Do not use in any manner other than instructed in this User's Guide.

#### Certifications & Patents

Conforms to EN61010-1:1993 + A1 + A2 and EN 61326  
 Listed 3058969. Conforms to Standard UL 61010A-1  
 Certified to CAN/CSA Standard C22.2, No. 1010.1-92  
 U.S.E.P.A. Company #73679, U.S. EPA Establishment #07369-ME-001  
 U.S. Patent Numbers 5,900,212 & 6,110,424 & 6,579,495  
 Patents and patents pending in U.S. and worldwide.



SteriPEN® is a registered trademark of Hydro-Photon, Inc. © 2010 Hydro-Photon, Inc. All rights reserved.



SteriPEN® is tested and certified by the Water Quality Association against the US EPA Microbiological Water Purifier Standard.

#### How does SteriPEN® Adventurer<sup>Opti</sup> disinfect water?

SteriPEN® Adventurer<sup>Opti</sup> uses short wave germicidal UV light to disinfect water. This range of UV light disrupts the DNA within bacteria, viruses and protozoa, rendering them unable to reproduce and therefore, harmless. For more detailed information, visit our web site at [www.steripen.com](http://www.steripen.com).

#### Testing

At Hydro-Photon, we believe that careful testing is an important part of successful and responsible product development and quality control. A wide range of testing has gone into development and production of your SteriPEN® Adventurer<sup>Opti</sup>. To see our full microbiological test reports conducted at the University of Arizona, Tucson; University of So. Maine, Portland; University of Maine, Orono; Ryerson University, Toronto Ontario; A&L Laboratory, Auburn, ME; and Oregon Health Sciences University, Portland, visit the "Testing" section of our web site at: [www.steripen.com/testing.html](http://www.steripen.com/testing.html).

#### Distributors/Importers

##### U.S.A.

**Hydro-Photon, Inc.**  
 P.O. Box 675  
 262 Ellsworth Rd.  
 Blue Hill, Maine 04614 USA  
 Toll-Free: (888) 783-7473  
 Tel: (207) 374-5800  
 Fax: (207) 374-5100  
[info@steripen.com](mailto:info@steripen.com)  
[www.steripen.com](http://www.steripen.com)

SteriPEN® water purifiers are sold around the world. To find your nearest distributor, visit [www.steripen.com/dealerlocator](http://www.steripen.com/dealerlocator).

© 2010 by Hydro-Photon, Inc.  
 All rights reserved.

Hydro-Photon, Inc.  
 P.O. Box 675  
 262 Ellsworth Rd.  
 Blue Hill, ME 04614 USA  
 Tel: (207) 374-5800  
 Fax: (207) 374-5100  
[info@steripen.com](mailto:info@steripen.com)

[www.steripen.com](http://www.steripen.com)

MANOP1002