

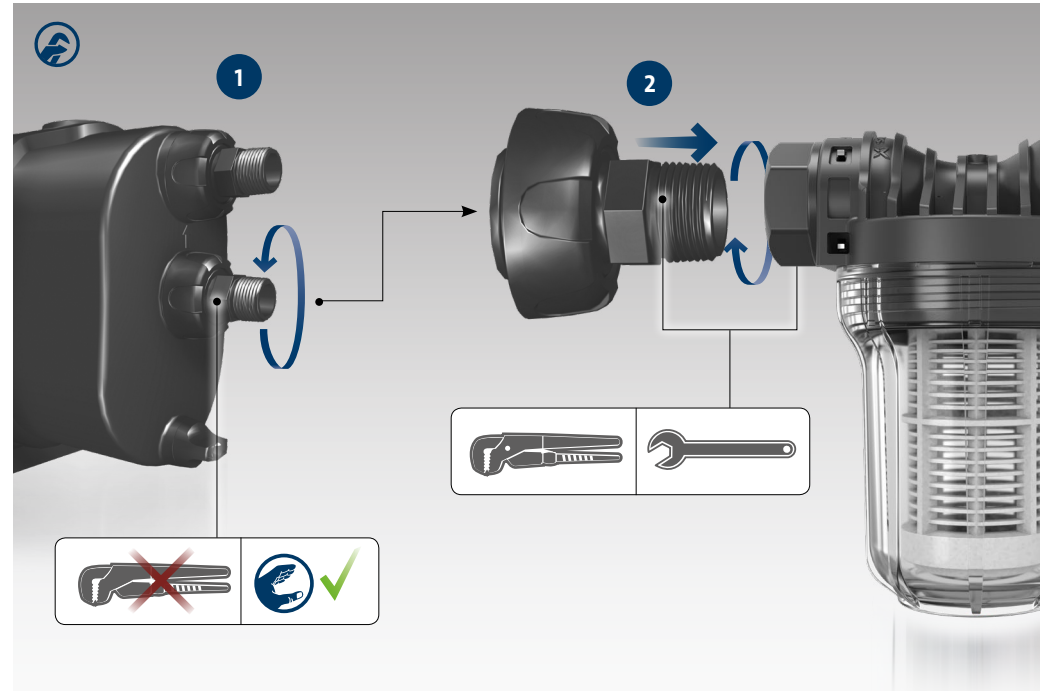

# INLET FILTER

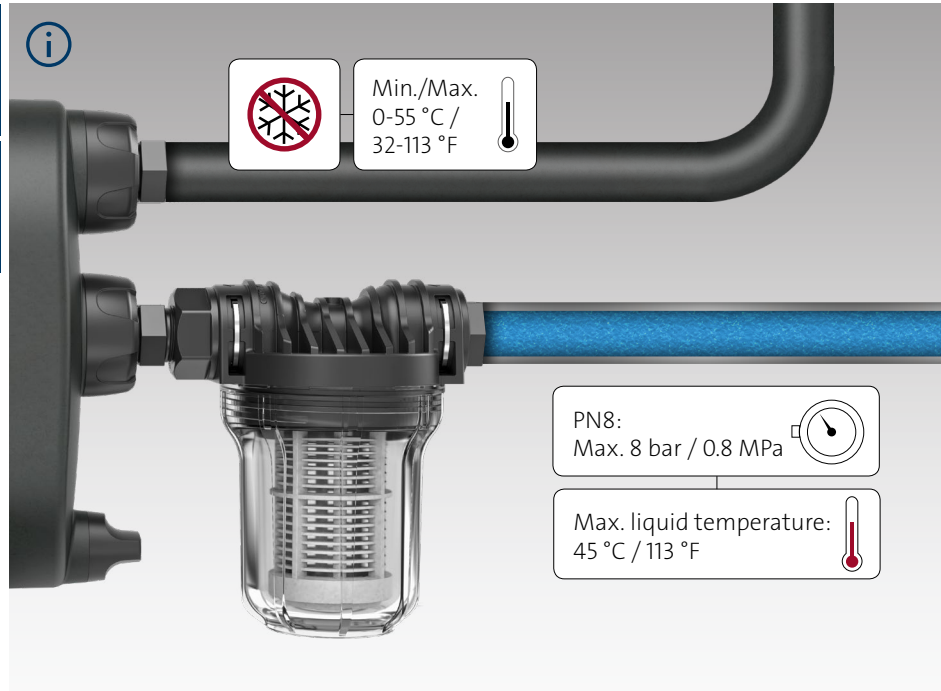

<http://qr.grundfos.com/i/99735562>





3



4

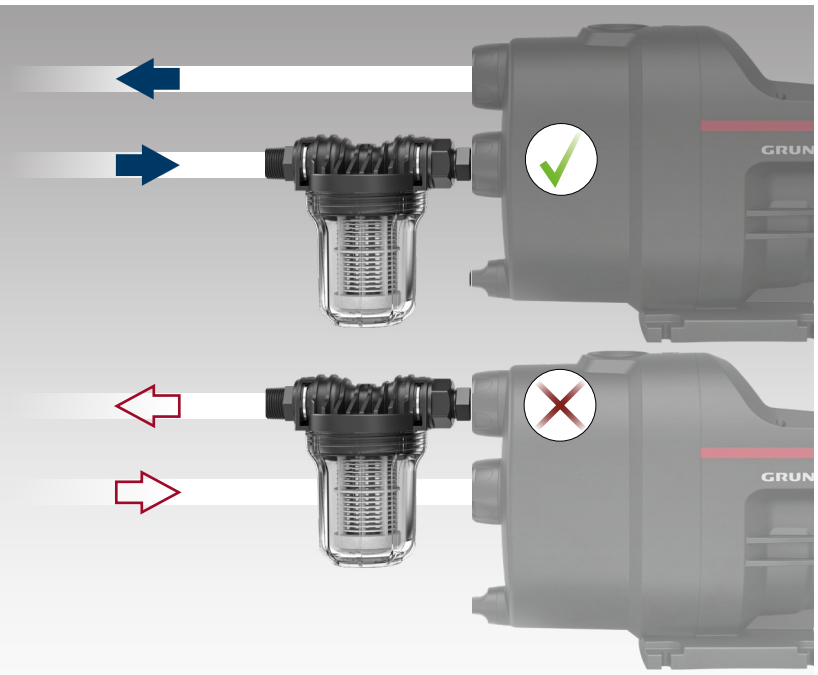
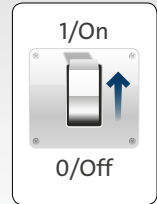
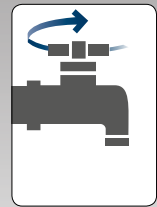

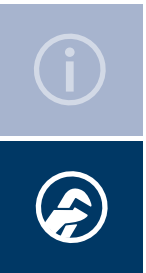

5

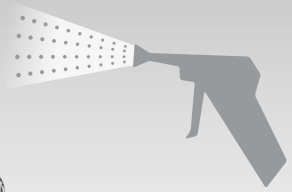

6

NOTES:

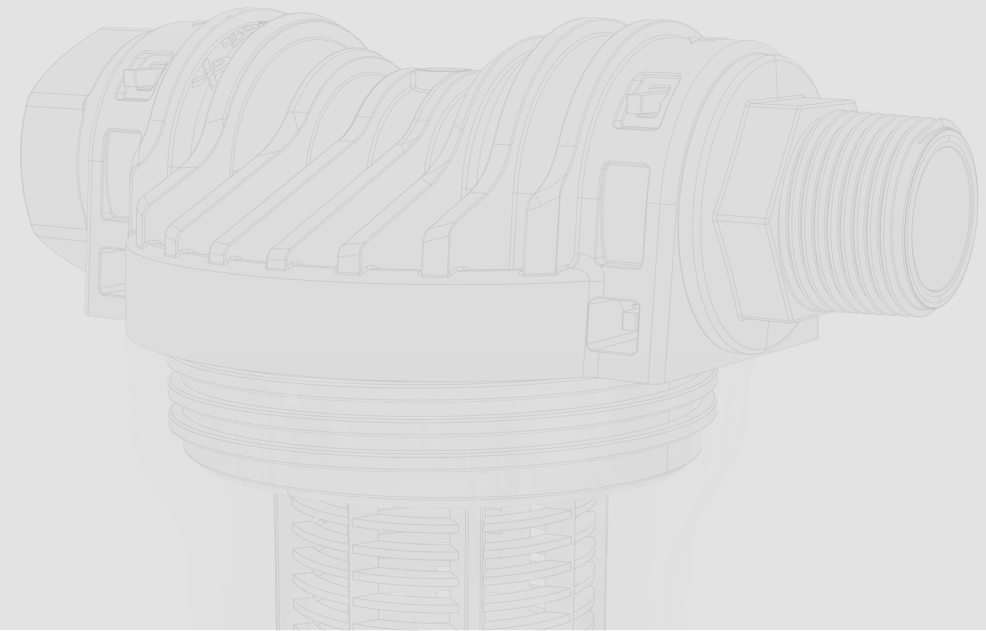

be think innovate

---

Installation date: \_\_\_\_\_

Installer:

\_\_\_\_\_  
\_\_\_\_\_  
\_\_\_\_\_  
\_\_\_\_\_  
\_\_\_\_\_

99735560 1019

ECM: 1273472

**GRUNDFOS Holding A/S**

Poul Due Jensens Vej 7

DK-8850 Bjerringbro

Tel: +45 87 50 14 00

[www.grundfos.com](http://www.grundfos.com)

Trademarks displayed in this material, including but not limited to Grundfos, the Grundfos logo and "be think innovate" are registered trademarks owned by The Grundfos Group. All rights reserved.

© 2019 Grundfos Holding A/S, all rights reserved.

**GRUNDFOS** 