

Series M2P0 SOLENOID VALVE

Model#
M2P201825F2A

2-way, Mini, Nylon Direct Acting Solenoid Valve,
Normally Closed

Technical Specifications

Pipe Size (Inch)	Orifice Size (Inch)	Flow Factor (CV)	
1/8"	3/32"	.21	
Voltage	Power	Min. Pressure (PSI)	Max Pressure (AC)
24VAC	6.8VA	0	120
Temperature Range	Medium Examples	Sealing Material	
5° - 320° F	Light Oils, Air, Water	FKM	
Response Time	Lead Wire Length		
6 - 20ms	12"		



Valve Dimensions

(F.F):	1/8"
(DN):	3/32"

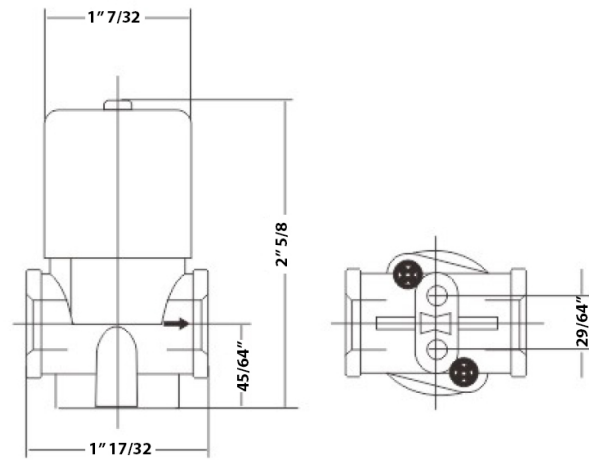

Electrical Connection

Rating:	NEMA 4/ IP 65
Connector:	Wire Leads