

## The only injection molded Trench Drain

- Non-corrosive.
- 235 p.s.i industrial strength
- H-20 wheel load rating

Comes completely assembled. One unit. One price. No Extras.

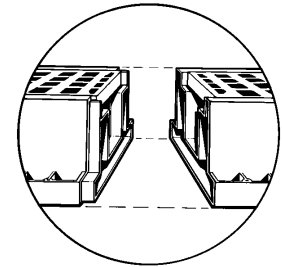
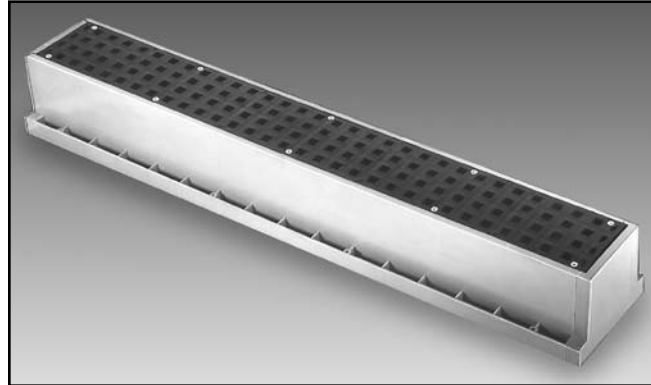

## Interlocking Molded Ends

No need to remove the grate during installation. Simply press trenches together for a Tuf-Tite free-flowing fit.

## Snap-on End Caps

Simply remove an end cap, extend the trench to any length, and re-install the end cap.

## Cut to Size

The trench may be field cut with a hand saw, and capped with a male end cap or a TR1-D4 End Drain

## Molded-In Ribs

Provide exceptional vertical compression strength - unequaled by other trench designs.

## Choice of 3 Drains

Three bottom drains are molded in. Knock-out membranes allow trench to be drained with 2" or 3" Schedule 40, or 4"

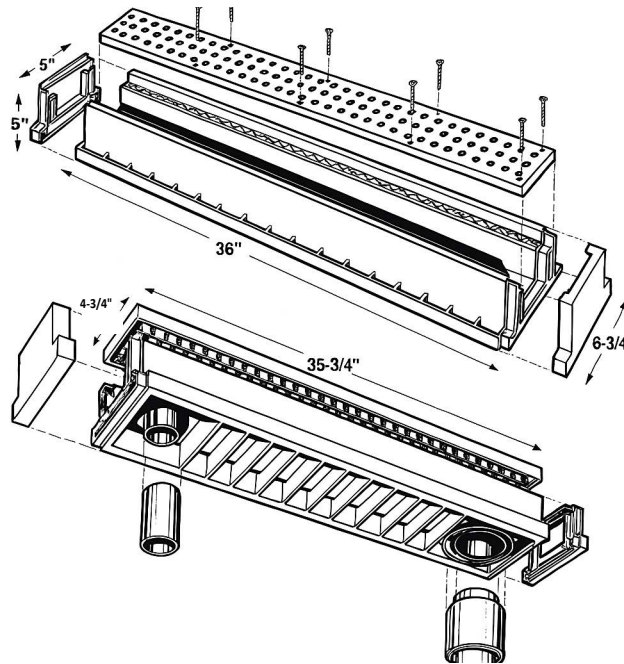

## ADA Compliant Grate

Safe, square 1/2" x 1/2" openings.

## Stainless Screws

The grate is held in place with 10 SS screws.

## Americans With Disabilities Act

*Regulation 4.5.4:* If gratings are located in walking surfaces, then they shall have spaces no greater than 1/2" (13mm) wide in one direction. If gratings have elongated openings, then they shall be placed so that the long dimension is perpendicular to

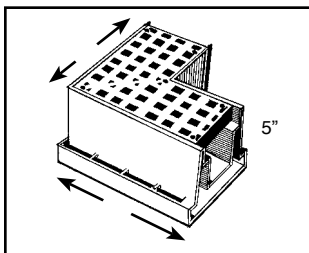

## TR1-90 Corner

90° injection molded corner unit for Trench Drain. Molded interlocking ends for simple, snap-together installation. Comes assembled with grate and 6 SS stainless screws. ADA compliant.

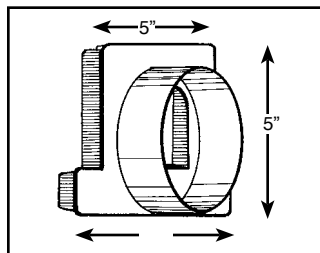

## Optional End Drain TR1-D4

Male End Drain snaps on female end of Trench Drain. Accepts:

- 4" SDR35-3034 pipe
- 4" 2729 pipe
- 4" corrugated pipe when used with an MF-4 pipe connector

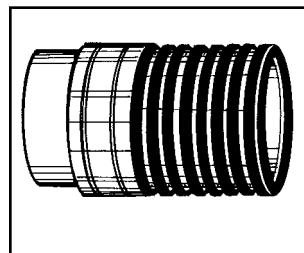

## MF-4 Pipe Connector

To connect 4" corrugated pipe to the bottom of Trench Drain or to the End Drain TR1-D4. Provides a watertight fit.

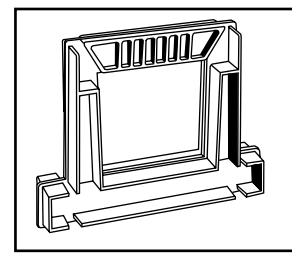

## Gender Changer

Changes male end to female (TR1-GCF) or female end to male (TR1-GCM)

## AD1 Area Drain with ADA Grate

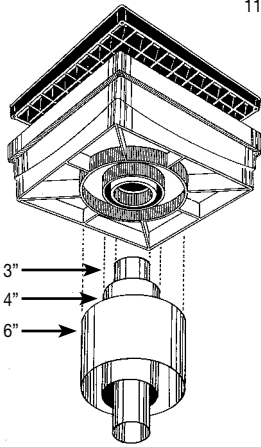
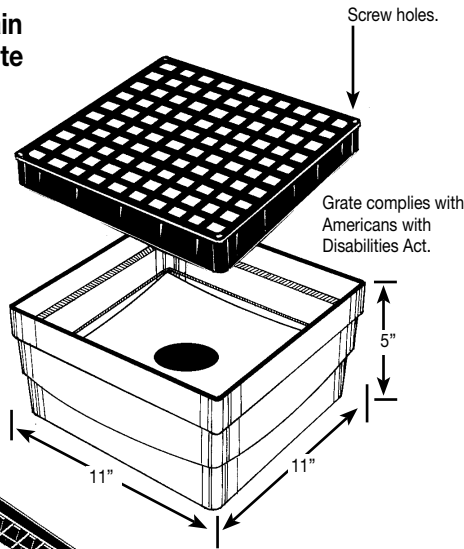

Choice of three size drain pipes.

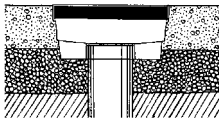

Installs easily inside and out.

- Rugged, Non-Corrosive**  
 Ribbed bottom provides exceptional compression strength.
- Steady Flow**  
 The contoured bottom directs all water to the drain. Standing water is eliminated.
- Easily Installed - Anywhere!**  
 Only 5" deep. Lightweight, easy to handle, and useable with 3", 4", or 6" pipe. No pipe fittings needed.
- Comes Complete**  
 Price includes a heavy duty ADA compliant grate. No extras required.

## 2-Hole Drain Sumps

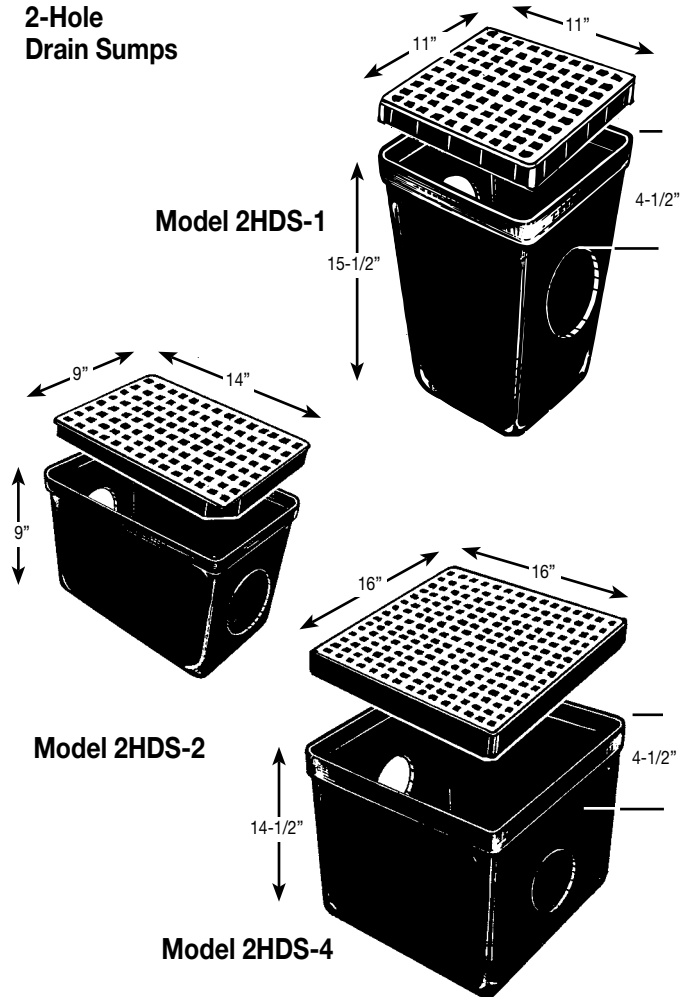

All Tuf Tite® Drain Sumps are injection molded. Select 1, 2, 3, or 4-hole Drain Sump with molded grate and your choice of snap-in watertight fittings:

- S-35 Yellow Seal for Thin Wall Pipe
- S-85 orange Plug for unused holes.

## Drainage and Septic Products

Tuf-Tite®  
 1200 Flex Court  
 Lake Zurich, Illinois 60047

