



Installation, Operation and Maintenance

# Owner's Manual



System Tested and Certified by NSF International against NSF/ANSI Standard 55 for Disinfection Performance, Class A.

MODELS: SPV-1.5, SPV-2.5, SPV-3.5, SPV-6, SPV-8, SPV-12, SPV-15, SPV-20

*ensuring the safety of your water*

Congratulations, you have just purchased the new Sterilight® Platinum™ UV disinfection system. By purchasing this device, you have taken the first step in ensuring the safety of your water supply by using a totally non-intrusive, physical disinfection method. Your Sterilight system uses the most advanced UV controller on the market and is designed to provide you with years of trouble free operation with minimal maintenance required.



# TABLE OF CONTENTS:

## **INSTALLATION:**

Parts	1
Safety Instructions	2
Water Chemistry	2
Installation Procedure	3-4
Lamp Installation and Replacement	5
Disinfection Procedure	6

## **MAINTENANCE:**

Quartz Sleeve Cleaning and Replacement	7
UV Sensor Cleaning and Replacement	8
Replacement Parts	9
Dry Contacts	9
Warning Systems	10-12
Troubleshooting	13-14





## **DETAILED SPECIFICATIONS AND INFORMATION:**

Flow Rates and UV Fluence	15-19
Specifications	20-22
Warranty	23

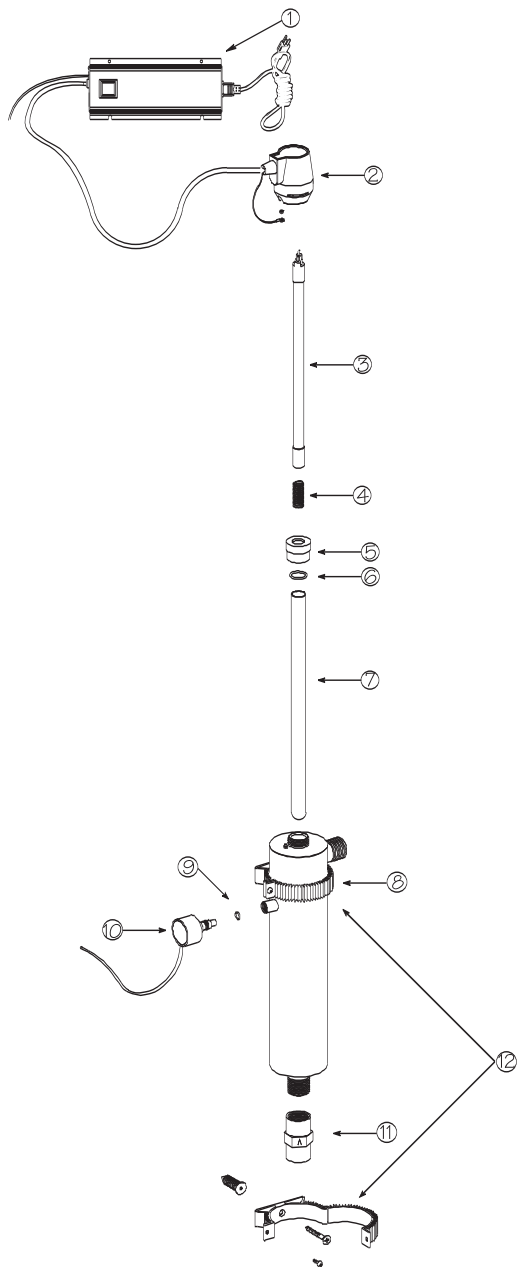
# PARTS:

Although your system was quality inspected at the factory, please review this document and ensure the following parts accompany this system:



- 1 Controller ..... 
- 2 Connector ..... 
- 3 Lamp .....   
*refer to page 9 for complete model and part numbers*
- 4 Spring
- 5 Gland Nut
- 6 O-Ring
- 7 Quartz Sleeve ..... *refer to page 9 for complete model and part numbers*
- 8 Reactor ..... 
- 9 Sensor O-Ring
- 10 UV Sensor ..... 
- 11 Flow Restrictor ..... *NSF/ANSI certified products only*
- 12 Mounting Clamps

# SAFETY INSTRUCTIONS:

**WARNING** - to guard against injury, basic safety precautions should be observed, including the following:

1. READ AND FOLLOW ALL SAFETY INSTRUCTIONS.
2. **DANGER** - to avoid possible electric shock, special care should be taken since water is present near electrical equipment. Unless a situation is encountered that is explicitly addressed by the provided maintenance and troubleshooting sections, do not attempt repairs yourself, refer to an authorized service facility.
3. Carefully examine the disinfection system after installation. It should not be plugged in if there is water on parts not intended to be wet.
4. Do not operate disinfection system if it has a damaged cord or plug, if it is malfunctioning or if it has been dropped or damaged in any manner.
5. Always disconnect water flow and unplug disinfection system before performing cleaning or maintenance activities. Never yank the cord to remove from an outlet; grasp the wall plug and pull to disconnect.
6. Do not use this disinfection system for other than intended use (potable water applications). The use of attachments not certified, recommended or sold by the manufacturer/distributor may cause an unsafe condition.
7. Installation of this UV system must be in accordance with Provincial/State and local laws and regulations for plumbing and electrical.
8. Intended for indoor use only. Do not install this disinfection system where it will be exposed to outdoor weather or to temperatures below freezing. Do not store this disinfection system where it will be exposed to outdoor weather. Do not store this disinfection system where it will be exposed to temperatures below freezing, unless all water has been drained from it and the water supply has been disconnected.
9. Read and observe all the important notices and warnings on the disinfection system.
10. Connect to a properly grounded outlet. If an extension cord is used, ensure it is of a sufficient rating and properly grounded.
11. SAVE THESE INSTRUCTIONS.

# WATER CHEMISTRY:

Water quality is extremely important for the optimum performance of your UV system. The following levels are recommended for installation:

- **Iron:** < 0.3 ppm (0.3 mg/L)
- **Hardness\*:** < 7 gpg (120 mg/L)
- **Turbidity:** < 1 NTU
- **Manganese:** < 0.05 ppm (0.05 mg/L)
- **Tannins:** < 0.1 ppm (0.1 mg/L)
- **UV Transmittance:** > 75% (call factory for recommendations on applications where UVT < 75%)

*\* Where total hardness is less than 7 gpg, the UV unit should operate efficiently provided the quartz sleeve and/or sensor probe is cleaned periodically. If total hardness is over 7 gpg, the water should be softened.*

If your water chemistry contains levels in excess of those mentioned above, proper pre-treatment is recommended to correct these water problems prior to the installation of your UV disinfection system. These water quality parameters can be tested by your local dealer, or by most private analytical laboratories. Proper pre-treatment is essential for the UV disinfection system to operate as intended.

# INSTALLATION PROCEDURE:

- The complete water system, including any pressure or hot water tanks, must be disinfected before start up by flushing with chlorine (household bleach) to destroy any residual contamination.
- The disinfection system should be connected to a ground fault interrupter.
- The disinfection system is intended for indoor use only. Do not install the system where it may be exposed to the weather.
- Install the disinfection system on cold water line only.
- If treating the entire house, install the disinfection system before any branch lines. Ideally, your disinfection system should be the last treatment your water receives prior to use.
- A 5 micron sediment filter must precede the disinfection system.

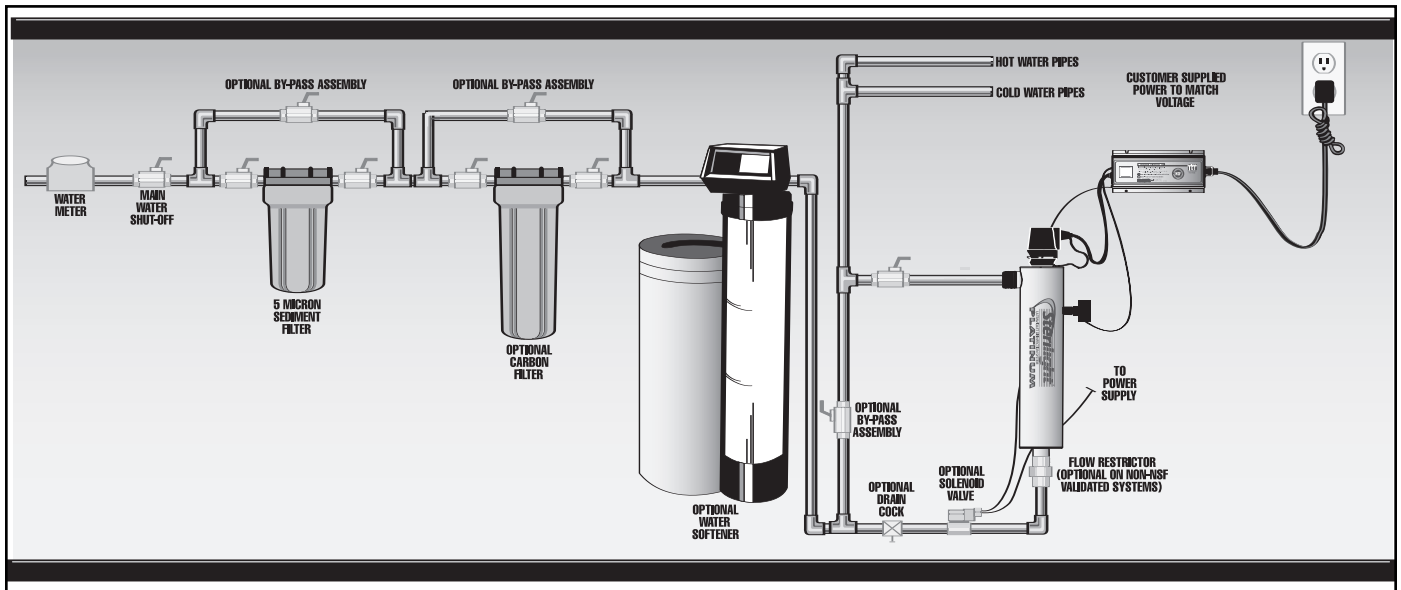

1. The above picture shows the installation of a typical disinfection system and the related components that may be used for the installation. The use of a by-pass assembly is recommended in case the system requires “off-line” maintenance. If this is the case, it must be noted that the system will require supplementary disinfection of the distribution system if any water is used during this condition of by-pass. In addition, during by-pass, the water will NOT be disinfected and the attached “DO NOT CONSUME THE WATER” tag (included with the system), should be physically installed on the by-pass assembly until such time as the system is sanitized and returned to service. Please refer to the complete disinfection procedure as outlined on page 5 of this document. If the water is to be consumed while the system is off-line, the water must be boiled for twenty minutes prior to consumption.

2. Select a suitable location for the disinfection system and its related components. As it is recommended to install a ground fault protected circuit (GFCI), make sure that this is taken into consideration prior to any installation. The system can either be installed vertically (inlet port at the bottom) (Figure 1a), or horizontally (Figure 1b), however the vertical installation is the most preferred method. When selecting a mounting location, you must also leave enough space to allow for the removal of the UV lamp and/or quartz sleeve (typically leave a space equal to the size of the reactor chamber itself).

3. Mount the system to the wall using the supplied clamps. Various connection methods can be used to connect the water source to the system, however union type connectors are recommended. The use of a flow restrictor device is strongly recommended when installing your system in order that the manufacturers recommended flow rate is not exceeded. This flow restrictor is mandatory on the SPV series systems and is included with these systems. The flow restrictor should be installed on the inlet port and is designed to be installed in one direction only. Ensure that the flow of the water matches the flow direction as indicated on the flow restrictor (Figure 1c). **DO NOT SOLDER CONNECTIONS WHILE ATTACHED TO THE SYSTEM AS THIS COULD DAMAGE THE O-RING SEALS.**

4. Mount the Platinum ICE controller horizontally to the wall, near the reactor chamber. Ideally place the controller above the reactor and away from any water connection point, to prevent any water from potentially leaking onto the controller by means of a leak at a connection point or a “sweating” system. Make sure you allow for a “drip-loop” (Figure 1d) on the lamp, sensor and power cord, again, to prevent any water from potentially entering the controller. Affix the green ground wire to the grounding lug at the top of the reactor vessel and securely fasten with the locknut provided (Figure 1e).

5. Install the UV lamp and UV sensor as outlined on page 5 & 8.

6. Install the Safety-Loc™ lamp connector as outlined on page 5.

7. When all plumbing connections are made, slowly turn on the water supply and check for leaks. The most likely cause for leaks is from the o-ring seal. In case of a leak, shut water off, drain cell, remove the retaining nut, wipe the o-ring and threads clean and re-install.

8. Once it is determined that there are no leaks, plug the system into the ground fault interrupter, and check controller to ensure the system is operating properly. The controller is designed to detect both power to the system and lamp illumination. Although this Platinum UV system incorporates a safety interlock switch to prevent the UV lamp from being illuminated while outside the chamber, it is important to NEVER LOOK DIRECTLY AT THE BURNING UV LAMP. If you are looking for a secondary means of ensuring the UV lamp is operating, remove the lamp from the reactor and check the lamp for heat. The lamp should be physically warm if it was illuminated.

9. Allow the water to run for a few minutes to clear any air or dust that may be in the reactor.

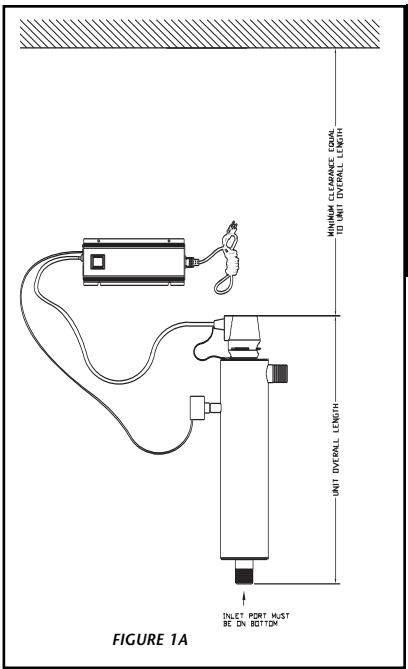

FIGURE 1A

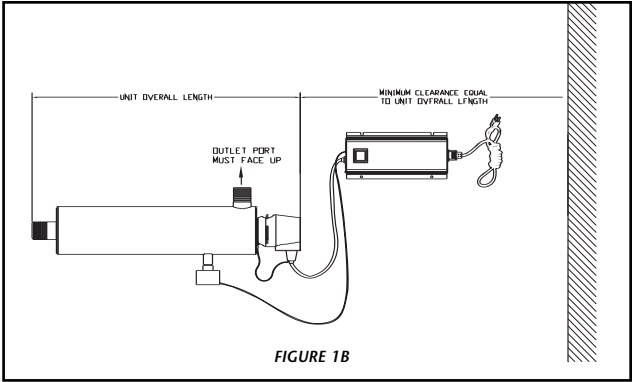

FIGURE 1B

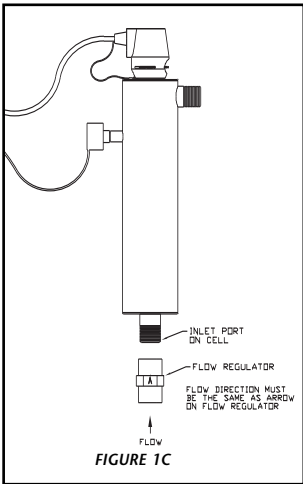

FIGURE 1C

**PLEASE NOTE:** When there is no flow, the water in the cell will become warm, as the UV lamp is always on. To remedy this, run a cold water tap anywhere in the house for a minute to flush out the warm water.

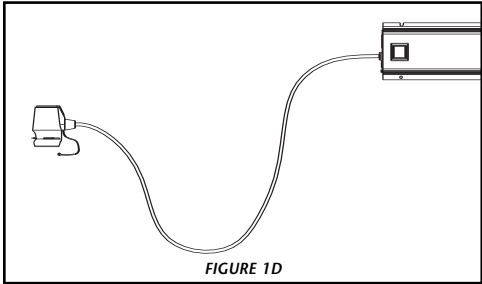

FIGURE 1D

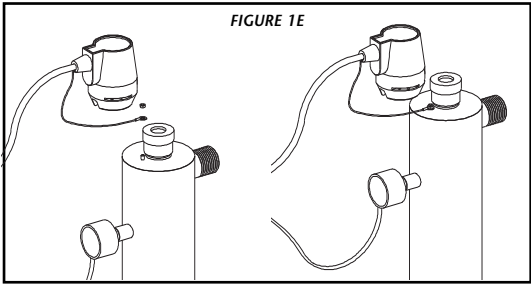

FIGURE 1E



# LAMP INSTALLATION/REPLACEMENT:

1. To replace the lamp, there is NO need to disconnect the system from the water supply, nor to drain the water from the reactor chamber. Lamp replacement is a quick and simple procedure requiring no additional or special tools. The UV lamp must be replaced after 9,000 hours of continuous operation (approximately one year) in order to ensure adequate disinfection. The controller will indicate when it is time to change the lamp (Figure 2a). As a measure of safety, this should be done even if the monitoring system that is included with the system indicates that the intensity of the lamp is still in a safe region.

2. Disconnect main power source and allow the unit to power down. Remove the Safety-Loc™ connector by sliding the metal retaining ring (Figure 2e) away from the body of the connector. Remove connector and lamp from the reactor chamber. Once you can visually see the lamp, separate the lamp from the connector (Figure 2c). Do not twist the lamp from the connector, simply slide the two apart. Avoid touching the lamp on the glass portion. Handling the lamp at the ceramic ends is acceptable, however if you must touch the lamp glass, please use gloves, or a soft cloth. Fully remove the lamp from the reactor chamber being careful not to angle the lamp as it is removed from the chamber. If the lamp is removed on an angle, pressure will be applied on the inside of the quartz sleeve, causing the sleeve to fracture.

3. To install a new lamp, first remove the lamp from its protective packaging again being careful not to touch the lamp “glass” itself. Carefully insert the lamp into the reactor vessel (actually inside the quartz sleeve) (Figure 2b). Insert the lamp fully into the chamber leaving about two inches of the lamp protruding from the chamber. Next, attach the Safety-Loc™ connector on the UV lamp. The connector is “keyed” and will only allow correct installation in one position. Ensure the connector is fully seated onto the UV lamp (Figure 2d).

4. Once the lamp is fully seated on the connector, slide the Safety-Loc™ connector over the aluminum retaining nut. Make sure the metal retaining ring on the Safety-Loc™ connector is pulled away from the body of the connector in order that the connector may slide fully over the retaining nut. Once the connector is located fully over the retaining nut, slide the metal ring back in to lock the connector in place (Figure 2f). As this Safety-Loc™ connector is keyed to the reactor chamber, make sure the depression on the connector (Figure 2e) is located over the ground lug located on the reactor chamber

**Note:** Even though the Safety-Loc™ connector contains an integral safety interlock switch which prevents the lamp from physically being illuminated when the lamp is removed from the chamber, it is still imperative that the system be disconnected from the power source before removing the lamp or working on the system.

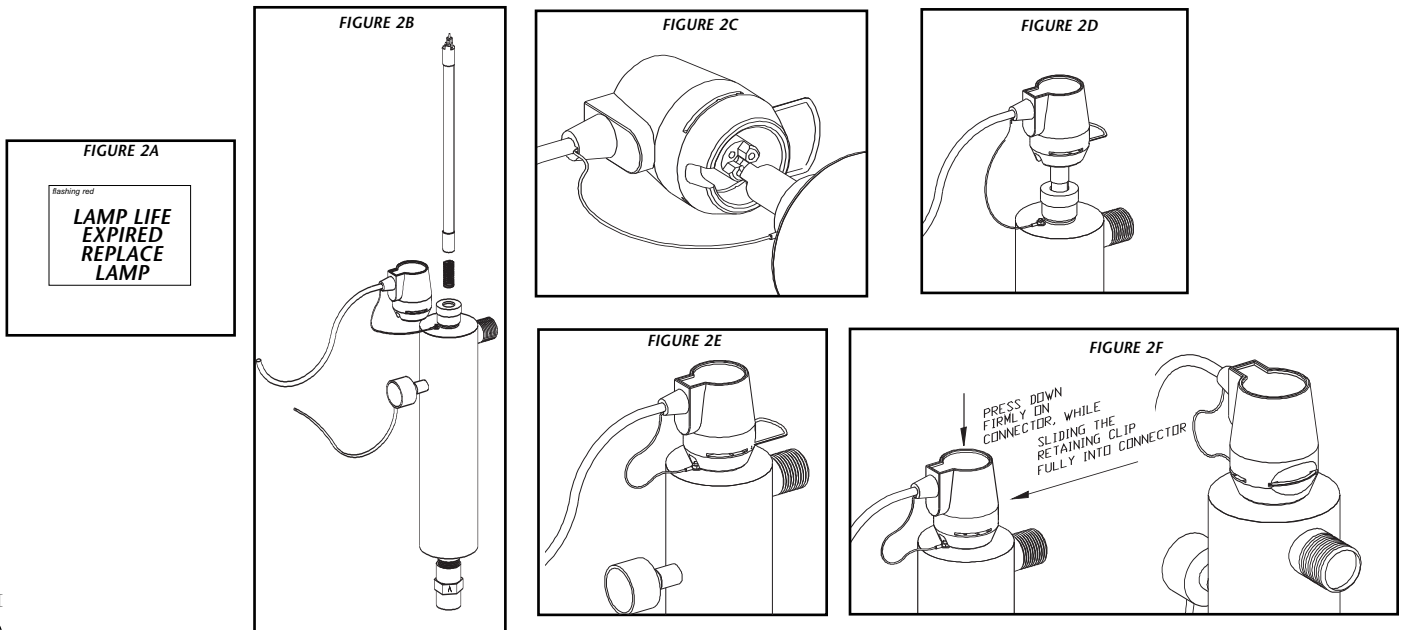



# DISINFECTION PROCEDURE:

UV disinfection is a physical disinfection process and adds nothing to the water. As there is no residual, it is imperative that the entire distribution system located after the UV be chemically disinfected to ensure that the water is free from any bacteriological contaminants. The disinfection process must be performed immediately after the UV unit is installed and repeated thereafter whenever the UV is shut down for service, without power, or inoperative for any reason. The procedure for sanitizing the plumbing system is readily accomplished as follows:

1. Remove the pre-filter cartridge and fill the sump with 1-2 cups of household (5.25%) bleach (chlorine) – Do **NOT** use hydrogen peroxide. At all times during this process, make sure the UV unit (and lamp) is turned on and operational!
2. Open every faucet and allow cold water to run until the chlorine is detected. When you smell chlorine, shut the faucet off and then repeat the process on the hot water side. You must ensure that all taps, including outside faucets, dishwashers, showerheads, washing machines, connections to refrigerators, toilets, etc., pass chlorinated water.
3. Once all the locations have passed the chlorine disinfection solution, you will need to leave the solution sit for a period of 20 – 30 minutes. Reinstall the pre-filter cartridge into the filter and then flush the chlorine solution from the system. Make sure that each fixture that was disinfected in step two is completely flushed of the chlorine solution as the consumption of this water is not advised due to the extremely high concentrations of chlorine. It is important to remember that in the event that a UV is briefly shut down for routine cleaning or during power interruptions where water could have passed through the system, the aforementioned procedure must also be followed.
4. The addition of chlorine (bleach) to a hot water tank that has in the past been fed with untreated raw water with high levels of other contaminants (iron, manganese, hydrogen sulphide, organics, etc.) will result in oxidation of these contaminants and may require repeated flushing of the hot water tank. This contingency must be dealt with independently under the start-up procedure for any other conditioners that may form a part of the pre-treatment for the UV unit.
5. The above procedure (Steps 1 to 3) will result in a massive chlorine residual far in excess of the 0.5 to 1.0 mg /L typically present in municipally chlorinated water and of a magnitude consistent with the minimum 50 mg/L chlorine solution recommended for the disinfection of distribution systems known to be contaminated.

**PLEASE NOTE:** As the Platinum systems include a 254nm UV intensity monitor, it should be noted that the introduction of the bleach solution required for disinfection **WILL** trigger a temporary low UV condition. This is due to the fact that the bleach physically “clouds” the raw water. Once the bleach runs through the system, the alarm condition will return to normal. To avoid the closing of the dry contacts in a solenoid installation, simply power up the system and once the sensor has been detected and indicates PASS on the smart switch the sensor should then be disconnected from the controller. The controller will complete its diagnostic setup, opening the dry contacts, allowing the flow of water. Once the bleach is out of the system, reconnect the sensor cable. The temporary alarm, “SENSOR FAILURE”, will sound until the sensor cable is reconnected.

## OPERATION

- Always disconnect power before performing any work on the disinfection system.
- Regularly inspect your disinfection system to ensure that the system is operational.
- Replace the UV lamp annually (or biennially if seasonal home use) to ensure maximum disinfection.
- Always drain the reactor chamber when closing a seasonal home or leaving the unit in an area subject to freezing temperatures.



# QUARTZ SLEEVE REPLACEMENT / CLEANING:

1. Mineral deposits and sediment may accumulate on the quartz sleeve decreasing the UV energy detected. Good maintenance of filtration equipment will reduce the accumulation of residues. If necessary, remove the quartz sleeve and clean with a commercially available scale remover (CLR, Lime-Away, etc.) and a lint free cloth. Repeat the process as often as necessary to keep the quartz sleeve clean. Be sure to remove all traces of cleaning fluid from the sleeve before it is reinstalled in the reactor (be sure not to allow liquid inside the sleeve).

2. First follow the procedures as outlined in the "Lamp Replacement" section on page 6.

3. Shut off the upstream water supply that feeds water into the reactor chamber.

4. Shut off the downstream water supply. If your system does not have a separate downstream valve, simply open a downstream faucet to release any pressure that may be built-up in the system.

5. After the UV lamp has been removed (Step 2), remove the aluminum retaining nut by turning counter clockwise (Figure 3a). Place a small pail under the reactor chamber to catch any water that may leak from the system. Grasp the quartz sleeve and fully remove from the reactor chamber. As with the lamp, make sure the sleeve is removed from the reactor chamber being careful not to angle the sleeve as it is removed from the reactor (Figure 3b). If the lamp is removed on an angle, pressure will be applied on the sides of the sleeve and against the reactor chamber, causing the sleeve to fracture.

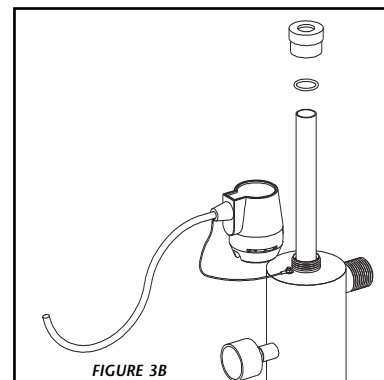
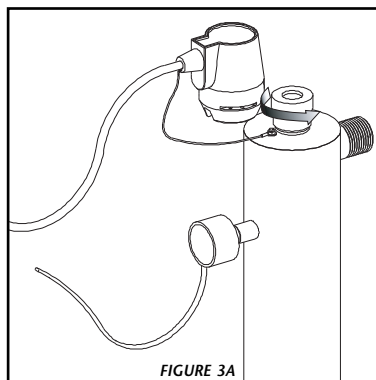

6. Clean the sleeve as outlined in Step one, or replace with a new sleeve. Reinstall the quartz sleeve in the reverse order. The Platinum reactor is designed for easy installation of the quartz sleeve by incorporating a unique sleeve centering guide. To install the sleeve, carefully insert the sleeve into the reactor chamber (do not drop) and push the sleeve until it firmly seats in the end of the reactor centered in the sleeve centering guides (Figure 3c). Install a lubricated (silicone release grease) o-ring (Part number OR-212) onto the sleeve until it is positioned against the chamfered seat (Figure 3d).

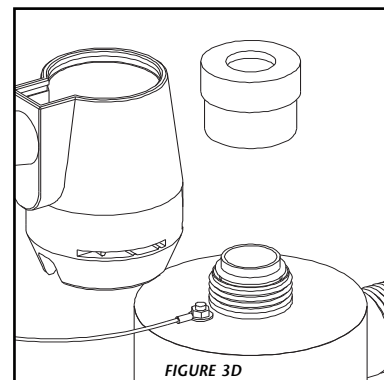
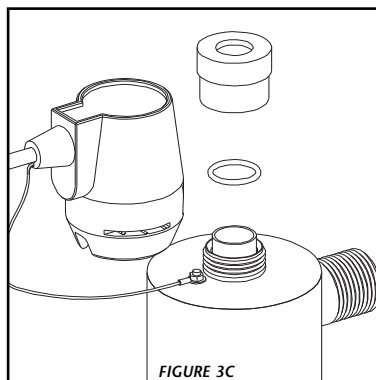

7. Reinstall the aluminum retaining nut on the reactor chamber and tighten by turning clockwise. The retaining nut should be hand-tightened only, the use of a wrench is not required, nor recommended. Reinstall the Safety-Loc™ connector as outlined in step four of the "Lamp Replacement" section.

8. Slowly turn on water and pressurize the reactor to verify that there are no leaks.

9. Reconnect to power source and follow the Controller start-up sequence to make sure the system is operating properly.

# UV SENSOR REPLACEMENT / CLEANING:



The UV sensor is an extremely sensitive and fragile instrument. Extreme care is required when handling and cleaning. The sensor window itself is constructed from quartz which is extremely fragile, be careful you do not chip or break this quartz window. Manufacturer's warranty does not cover damage due to neglect or misuse.

1. Mineral deposits and sediment may accumulate on the sensor window decreasing the UV energy detected. Good maintenance of pre-treatment equipment will reduce the accumulation of residues. If the system indicates that the UV intensity is low, one cause may be a stained quartz sleeve and/or sensor window (Figure 4a). If necessary, remove the sensor assembly and proceed with cleaning process. Repeat the process as often as necessary to keep the sensor window and quartz sleeve clean.
2. Before removing the sensor assembly, follow the steps as outlined in the "Quartz Sleeve Replacement And/Or Cleaning" section. The quartz sleeve should be cleaned at the same time as the UV sensor. Disconnect the UV sensor from the Platinum ICE controller by disconnecting the sensor cable (Figure 4b). To remove the sensor, grasp the stainless portion of the sensor and rotate counter-clockwise (Figure 4c) until the sensor is free of the threaded sensor port.
3. Once the sensor is free from the reactor chamber, clean the quartz window with a commercial scale remover (CLR or Lime-A-Way) and a lint free cotton swab (Figure 4d). Follow all manufacturer's instructions regarding the cleaning fluid used. Do not use an abrasive cleaner on the sensor window. Scratching of the sensor window will void any manufacturer's warranty on this item.
4. Carefully reassemble the sensor assembly into the sensor boss by first inserting the sensor o-ring (Figure 4e) and then the sensor itself. Screw the sensor into the boss and tighten to achieve a water-tight seal. DO NOT OVER TIGHTEN. Attach the sensor cable to the Controller and return to service (Figure 4f).

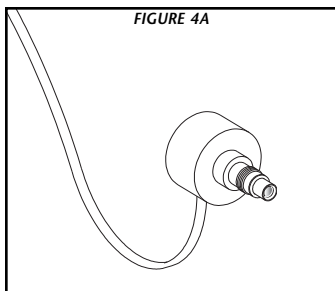

FIGURE 4A

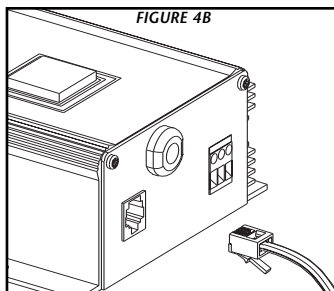

FIGURE 4B

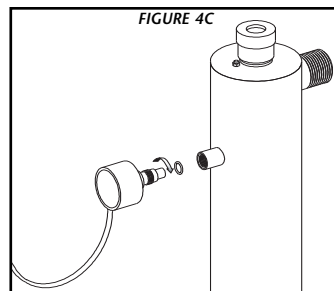

FIGURE 4C

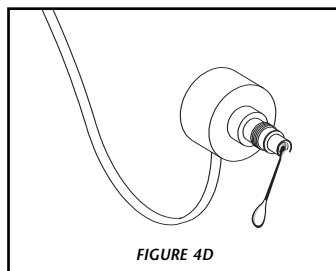

FIGURE 4D

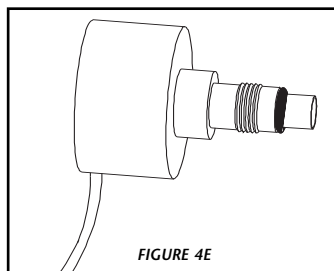

FIGURE 4E

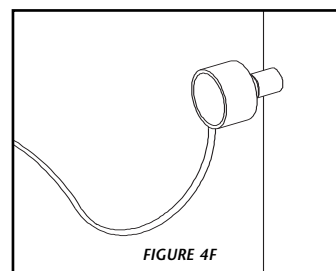

FIGURE 4F



# REPLACEMENT PARTS:

Model	UV Lamp	Quartz Sleeve	Controller	UV Sensor	Flow Restrictor	Sleeve O-Rings	Clamp	Retaining Nut
SP100-HO	S100RL-HO	QS-100	SPC-ICE-HO	254NM-FP1	N/A	OR-212	410076	RN-001
SP150-HO	S150RL-HO	QS-150	SPC-ICE-HO	254NM-FP1	N/A	OR-212	410076	RN-001
SP200-HO	S200RL-HO	QS-200	SPC-ICE-HO	254NM-FP1	N/A	OR-212	410076	RN-001
SP320-HO	S320RL-HO	QS-320	SPC-ICE-HO	254NM-FP1	N/A	OR-212	410076	RN-001
SP410-HO	S410RL-HO	QS-410	SPC-ICE-HO	254NM-FP1	N/A	OR-212	410076	RN-001
SP600-HO	S600RL-HO	QS-600	SPC-ICE-HO	254NM-FP1	N/A	OR-212	410076	RN-001
SP740-HO	S740RL-HO	QS-740	SPC-ICE-HO	254NM-FP1	N/A	OR-212	410076	RN-001
SP950-HO	S950RL-HO	QS-950	SPC-ICE-HO	254NM-FP1	N/A	OR-212	410076	RN-001
SPV-1.5	S100RL-HO	QS-100	SPC-ICE-HO	254NM-FP2	FRSS-1.5	OR-212	410076	RN-001
SPV-2.5	S150RL-HO	QS-150	SPC-ICE-HO	254NM-FP2	FRSS-2.5	OR-212	410076	RN-001
SPV-3.5	S200RL-HO	QS-200	SPC-ICE-HO	254NM-FP2	FRSS-3.5	OR-212	410076	RN-001
SPV-6	S320RL-HO	QS-320	SPC-ICE-HO	254NM-FP2	FRSS-6	OR-212	410076	RN-001
SPV-8	S410RL-HO	QS-410	SPC-ICE-HO	254NM-FP2	FRSS-8	OR-212	410076	RN-001
SPV-12	S600RL-HO	QS-600	SPC-ICE-HO	254NM-FP2	FRSS-12	OR-212	410076	RN-001
SPV-15	S740RL-HO	QS-740	SPC-ICE-HO	254NM-FP2	FRSS-15	OR-212	410076	RN-001
SPV-20	S950RL-HO	QS-950	SPC-ICE-HO	254NM-FP2	FRSS-20	OR-212	410076	RN-001

**Note:** Please contact factory for a list of authorized distributors in your area - t. 519.763.1032 t.f. 1.800.265.7246

# DRY CONTACTS:

Working in conjunction with the UV intensity monitor, the Platinum controller has a set of dry contacts. When the UV intensity monitor senses that the water is not adequately being treated and drops to 50% UV Intensity, the dry contact relay is activated. These contacts can be wired for a normally open (NO) or normally closed (NC) operation (Figure 6a). These dry contacts will remain either closed (NC) or open (NO), until the UV level rises above 50%. The dry contacts are typically used to operate a solenoid valve (Figure 6b), but can also be used to operate a horn, buzzer, or remote light. It should be noted that these are switches only; no power is supplied by these contacts. Any remote piece of equipment hooked up to the dry contacts must obtain their power from another source. The relay contacts are rated for 2A and 250 VAC to allow for a wide range of applications.

An optional junction box with wiring to connect the Platinum Controller to a solenoid valve is available. Contact factory for details.

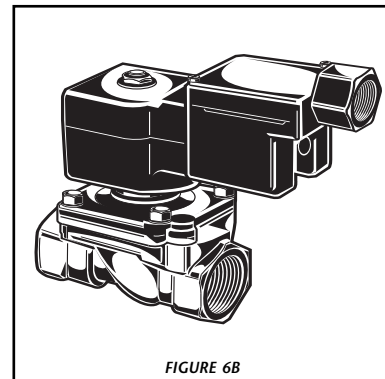
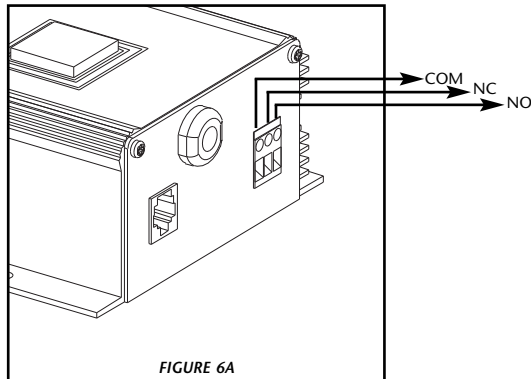

# WARNING SYSTEMS:

All Sterilight® Platinum™ UV disinfection systems incorporate the patent pending Platinum ICE™ controller and Flow Pace™ UV sensor. The coupling of these two components provides the most advanced UV monitoring/diagnostic/control device on the market. These two components provide the following controls:

## START-UP DIAGNOSTICS

Upon power-up, the Platinum Controller runs through a complete set of diagnostic tests and reports either a PASS or FAIL on the push-button display switch. The diagnostics are as follows:

<small>orange</small> <b>STARTING SELF TEST</b>	- initiation of start-up diagnostic check			
<small>orange</small> <b>POWER UP</b>	- power is applied to the controller and starts the lamp preheat circuit, displays ...	<small>green</small> <b>PASS</b>	OR	<small>red</small> <b>FAIL</b>
<small>orange</small> <b>SENSOR CHECK</b>	- checks to see if the UV sensor is physically connected to the controller, displays...	<small>green</small> <b>PASS</b>	OR	<small>red</small> <b>FAIL</b>
<small>orange</small> <b>REMOTE ALARM SEARCH</b>	- checks for the presence of an external remote alarm, displays...	<small>green</small> <b>PASS</b>	OR	<small>red</small> <b>REMOTE ALARM NOT DETECTED</b>
<small>orange</small> <b>INTERLOCK CHECK</b>	- checks the status of the safety interlock switch on the lamp connector, displays ...	<small>green</small> <b>PASS</b>	OR	<small>red</small> <b>INTERLOCK OPEN</b>
<small>orange</small> <b>STARTING LAMP</b>	- physically starts the UV lamps, if successful, continues to next screen, or in the event of a failure, the systems tries to start the lamp three times, if unsuccessful, displays ...	<small>green</small> <b>PASS</b>	OR	<small>flashing red</small> <b>LAMP FAILURE</b>
<small>orange</small> <b>DRY CONTACTS ACTUATOR CHECK</b>	- checks the dry contacts for continuity, displays ... (Note: you will hear a "clicking" sound when the contacts are checked)	<small>green</small> <b>PASS</b>	OR	<small>red</small> <b>FAIL</b>

Once all the diagnostics are complete, the system shows were successfully completed.



the screen indicating that all diagnostics

## UV INTENSITY

The Flow-Pace™ UV sensor detects the discrete 254nm wavelength of the UV lamp. This information is relayed to the Platinum ICE controller and is displayed in “% UV Output”. The intensity is displayed by pressing the push-button switch a single time.

The intensity is displayed as follows: (Note: “H” indicates unit operating in **full** power mode, “L” indicates unit is operating in reduced power mode. System will not switch to reduced power mode if water temp is below 20°C or UV level drops below 55%.)

green  
**100%<sup>H</sup>  
UV LEVEL**

UV level between 65 to 100%...the system is functioning within normal operating range and the UV level is displayed in green on the screen.

green  
**65%<sup>L</sup>  
UV LEVEL**

orange  
**64%<sup>H</sup>  
UV LEVEL**

UV level is between 56 to 64%...the UV level is still within a safe level, however at this level the system should be examined to determine why the UV level is this low. The UV level at this range is displayed in amber on the screen.

orange  
**56%<sup>H</sup>  
UV LEVEL**

flashing red  
**55%<sup>H</sup>  
UV LEVEL**

UV level is between 50 to 55%...the UV level is nearing the point of unsafe UV intensity. At this level (40 mJ/cm<sup>2</sup> for NSF/ANSI units), the system should be closely examined to determine why the UV level is this low. The UV level at this range is displayed in a flashing red on the screen and the audible alarm is beeping intermittently.

flashing red  
**50%<sup>H</sup>  
UV LEVEL**

red  
**49%<sup>H</sup>  
UV LEVEL**

UV level is between 20 to 49%...the UV level has now reached a level that indicates a UV level that is unsafe (below 40 mJ/cm<sup>2</sup> for NSF/ANSI units). At this level the water should not be consumed. The system should be examined to determine the reason for the low level of UV intensity. At this level, the dry contacts have been activated, the screen is solid red and the audible alarm is beeping constantly.

red  
**20%<sup>H</sup>  
UV LEVEL**

**Note:** Audible alarm can be switched off for 12 hours by pressing and holding the display push button for 5 seconds only when audible alarm is activated. Dry contacts will continue to be activated and LOW UV LEVEL alarm will continue to be displayed.

red  
**LOW<sup>H</sup>  
UV LEVEL**

UV level is less than 20%...the UV level is too low for the system to read and the screen is solid red and the audible alarm is beeping constantly.



**THIS ADVANCED WARNING SYSTEM HAS BEEN INSTALLED TO PROVIDE YOU WITH THE OPTIMUM PROTECTION AGAINST MICROBIOLOGICAL CONTAMINATION IN YOUR WATER. DO NOT DISREGARD THE WARNING LIGHTS.**

**THE BEST WAY TO CHECK UV OPERATION IS TO HAVE THE WATER TESTED FOR BACTERIA BY A RECOGNIZED TESTING AGENCY ON A REGULAR BASIS.**

## POSSIBLE CAUSES FOR LOW UV ALARM CONDITIONS

- The UV lamp has reached a level whereby it can no longer adequately provide a sufficient level of disinfection. The lamp should be replaced with a new lamp from the manufacturer of the same size and type.
- The quartz sleeve and/or the sensor window have become stained or dirty. Mineral deposits or sediment in the water that was not detected during the original water analysis may be the cause for this.
- Intermittent voltage drop in the household power supply reducing the lamp output. The lamp will return to normal when the power is restored to full voltage. Note: the monitoring system will not operate during power failures.
- The quality of the influent water has changed and is no longer within the acceptable operational range of the UV system. Perform a water analysis to determine the exact constituents and concentration levels.

## HOUR METER

green  
**325 dy  
LAMP LIFE**

### DAY COUNTDOWN

The controller tracks the hours of operation of the lamp and controller. To activate, press the push-button switch two times in succession (first press will display UV Intensity). The controller displays the number of days remaining until the lamp requires changing. From 365 – 31 days remaining, the switch will be displayed in green (Figure 5a). From 30 – 1 day remaining, the switch will be displayed in amber (Figure 5b) and when one year of operation has passed, the switch will be displayed in red (Figure 5c). Once the 365-day countdown period has expired, the controller will display “LAMP LIFE EXPIRED, REPLACE LAMP” message on a flashing red screen (Figure 5d). This indicates that the lamp should be replaced. The countdown feature can be set back to 365 days by physically disconnecting the power source and then reapplying power to the controller while depressing (and holding) the push button switch (approximately 2-3 seconds until you hear a “long-beep”). It is recommended to reset this countdown each time the lamp is changed.

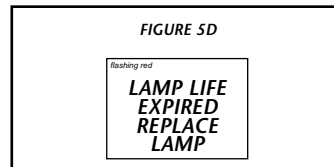
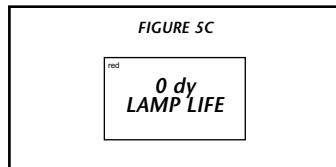
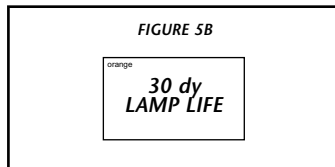
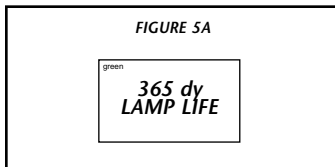

orange  
**ALARM  
DEFERRED  
FOR  
7 DAYS**

Once the lamp “life expired, “replace lamp”” screen is shown, the alarm can be deferred up to four times by pressing the push-button switch. The first time the switch is depressed, the alarm is deferred for seven days. The second time the switch is depressed; the alarm is deferred for another seven days. The third time the switch is depressed; the alarm is again deferred for seven more days. Once the final seven-day deferral has been reached, the alarm can no longer be deferred by pressing the switch. At this stage, the only way to eliminate the alarm is to replace the lamp and manually reset the controller. To accomplish this, physically disconnect the power source, change the lamp, and then reapply power to the controller while depressing (and holding) the push button switch (approximately 2-3 seconds until you hear a “long-beep”). Once you hear the beep, let go of the switch and the counter will be reset. The delay switch is designed to allow you time to address the alarm while you obtain a new UV lamp. Even though the alarm on the system can be deferred for a period of time, it is important to address the alarm condition as it is indicating that there is a potential problem with the system which should be remedied.

green  
**90 X100  
HRS OF OP.**

### TOTAL HOURS

The controller also displays the total running time of the controller. To obtain this reading, press the push-button switch three times in succession (first press will display UV Intensity, second press will display day countdown). The total running time of the controller will be displayed as a number. To obtain the actual hours of operation, simply multiply the number displayed by 100 (i.e., 90 represents 9,000 hours or approximately one year of operation). It should be noted that this value cannot be reset.

flashing red  
**LAMP  
FAILURE**

### LAMP FAILURE

The controller continuously monitors the status of the UV lamp. Upon lamp failure, the system reverts to the “Lamp Failure Mode” and tries to start the lamp for three times in succession. If unsuccessful, “LAMP FAILURE” is represented on the Controller in a flashing red screen and an audible alarm is activated.

flashing red  
**SENSOR  
FAILURE**

### SENSOR FAILURE

The controller continuously monitors the status of the UV sensor. Upon sensor failure, the “SENSOR FAILURE” is displayed on the Controller in a flashing red screen and an audible alarm is activated.



# TROUBLESHOOTING:

## TROUBLESHOOTING GUIDE

**Caution:** When performing any work on the disinfection system unplug the unit first and never look directly at the burning UV lamp.

SYMPTOM	POSSIBLE CAUSES	REMEDY
<p align="center"><b>PRESSURE DROP</b></p>	<ul style="list-style-type: none"> <li>the sediment pre-filter is clogged</li> </ul>	<ul style="list-style-type: none"> <li>replace filter cartridge with appropriate five micron cartridge, <i>Note:</i> check source water supply as fluctuations may occur in source pressure</li> </ul>
	<ul style="list-style-type: none"> <li>flow regulator</li> </ul>	<ul style="list-style-type: none"> <li>flow regulator will result in pressure drop when approaching full flow</li> </ul>
<p align="center"><b>HIGH BACTERIA COUNTS</b></p>	<ul style="list-style-type: none"> <li>quartz sleeve is stained or dirty</li> </ul>	<ul style="list-style-type: none"> <li>clean sleeve with scale cleaner and eliminate source staining problem</li> </ul>
	<ul style="list-style-type: none"> <li>change in feedwater quality</li> </ul>	<ul style="list-style-type: none"> <li>have the source water tested to ensure it is still within the allowable parameters for use with this unit</li> </ul>
	<ul style="list-style-type: none"> <li>contamination after the disinfection system</li> </ul>	<ul style="list-style-type: none"> <li>it is imperative that the effluent water stream be shocked with chlorine after the water leaves the system - the disinfection system must have a bacteria free distribution system to work effectively</li> </ul>
<p align="center"><b>WARM PRODUCT WATER</b></p>	<ul style="list-style-type: none"> <li>common problem caused by infrequent use</li> </ul>	<ul style="list-style-type: none"> <li>run water until it returns to ambient temperature</li> </ul>
<p align="center"><b>WATER APPEARS "MILKY"</b></p>	<ul style="list-style-type: none"> <li>caused by air in the water lines</li> </ul>	<ul style="list-style-type: none"> <li>run water until air is purged</li> </ul>
<p align="center"><b>UNIT LEAKING WATER</b></p>	<ul style="list-style-type: none"> <li>problem with o-ring seal (on gland nut and/or UV sensor)</li> </ul>	<ul style="list-style-type: none"> <li>ensure the o-ring is in place, check for cuts or abrasions, clean o-ring, moisten with water and re-install, replace if necessary (Part# OR-212)</li> </ul>
	<ul style="list-style-type: none"> <li>condensation on reactor chamber caused by excessive humidity and cold water</li> </ul>	<ul style="list-style-type: none"> <li>check location of disinfection system and control humidity</li> <li>protect cell with protective insulation</li> </ul>
	<ul style="list-style-type: none"> <li>inadequate inlet / outlet port connections</li> </ul>	<ul style="list-style-type: none"> <li>check thread connections, reseal with Teflon™ tape and re-tighten</li> </ul>

<b>DISPLAY FAULT MODES</b>	
<i>Platinum ICE controller will monitor and display operating conditions and warn of any faults or alarm conditions.</i>	
<b>LAMP LIFE EXPIRED</b>	<ul style="list-style-type: none"> <li>• replace lamp with manufacturers replacement</li> </ul>
<b>SENSOR FAILURE*</b>	<ul style="list-style-type: none"> <li>• ensure UV sensor cable is properly connected to controller</li> <li>• disconnect sensor for 5 seconds to re-set sensor</li> <li>• replace UV sensor</li> </ul>
<b>INTERLOCK OPEN</b>	<ul style="list-style-type: none"> <li>• ensure lamp connector is fully seated to the gland nut and that the locking clip is in place</li> </ul>
<b>LAMP FAILURE</b>	<ul style="list-style-type: none"> <li>• ensure that the UV lamp is properly engaged to the lamp connector</li> <li>• lamp connector contacts are corroded</li> <li>• old lamp, replace lamp</li> </ul>
<b>LOW UV LEVEL*</b>	<ul style="list-style-type: none"> <li>• clean quartz sleeve and Flow-Pace™ sensor lens</li> <li>• check UVT (water quality)</li> <li>• replace UV lamp</li> <li>• replace Flow-Pace™ sensor</li> </ul>
<p><b>*NOTE:</b> SENSOR FAILURE and LOW UV LEVEL alarms can be silenced for a 12 hour period by pressing and holding the display push button for 5 seconds only when the audible alarm is activated. Dry contacts will continue to be activated and visual display will continue to display failure mode.</p>	

- Your new Sterilight Platinum disinfection system includes an indicator to advise when the water temperature has exceeded 40°C (10°F).
- When the water temperature exceeds the maximum rating, the controller will indicate a unique type of indicator by flashing the default logo screen between green and amber colours. By pressing the green/amber flashing screen, the display will change to solid amber with the letters "OT" to give explicit indication of the "Over-Temperature" condition.
- If this over-temperature condition has been caused by extended time periods of no water flow (it is natural for the UV chamber to warm-up in such cases), simply open a faucet and allow some water to flow through the system.
- In event of either a lamp failure or sensor failure occurring during an over-temperature condition, the display screen will immediately change to flashing red with specific wording to advise of the lamp or sensor failure, and the audible alarm will sound. Also, the solenoid valve dry contacts will activate immediately in event of either lamp or sensor failure.

# FLOW RATES AND UV FLUENCE (DOSE):

[ THIS SECTION APPLIES TO THE NON-NSF/ANSI CERTIFIED PRODUCTS ONLY ]

To fully comprehend how UV systems can be sized, one must first understand the concept of fluence (dose). UV fluence is simply the product of UV intensity and time. The UV intensity is represented by the actual UV energy produced by the lamp while the time portion is represented by the residence time that the water resides in the reactor chamber. The net result is UV fluence (dose) stated in  $\text{mJ}/\text{cm}^2$ .

**UNIT COMPARISON**  
 $1 \text{ mJ}/\text{cm}^2 = 1000 \text{ }\mu\text{Wsec}/\text{cm}^2 = 10 \text{ J}/\text{m}^2$

Currently, there is much discussion surrounding this topic. Over the years manufacturers have rated their units at a variety of different flow rates at a specified UV fluence. To complicate this matter further, water quality is of significant importance to this equation. More specifically, the UV transmittance (UVT) of the water will greatly affect the delivered fluence (dose). A unit that is rated at 10 gpm at a UV dose of  $40 \text{ mJ}/\text{cm}^2$  at 98% UVT may only deliver a dose of  $20 \text{ mJ}/\text{cm}^2$  at a UVT of 75%. This is obviously a significant factor and MUST be taken into account when correctly sizing a UV system. We at R-Can provide the customer with Fluence vs. Flow Rate charts for each one of our Platinum UV systems. These charts graphically show how the flow rate is affected dependent upon both the fluence selected as well as the UVT of the water. Without this kind of information, a comparison of different UV units CANNOT be accurately made. One cannot compare UV systems by flow rate only unless both the fluence and UVT are equivalent!

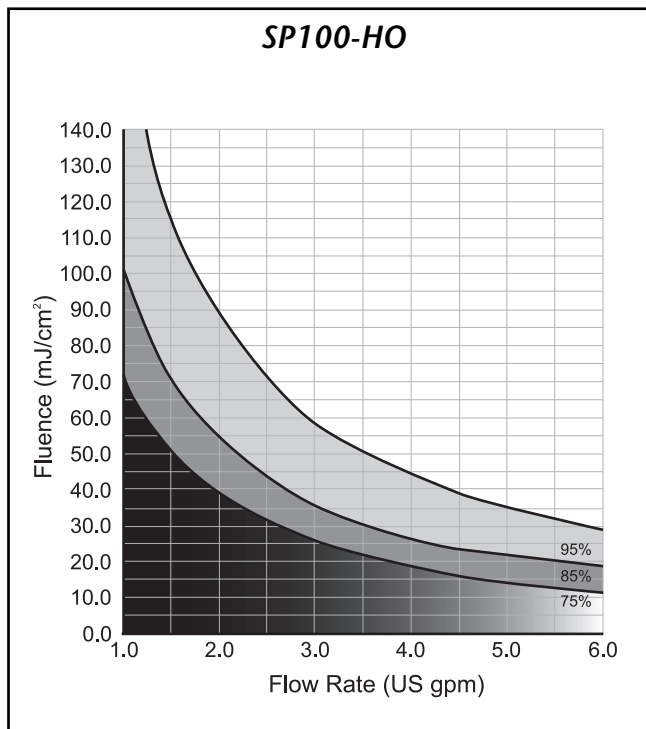

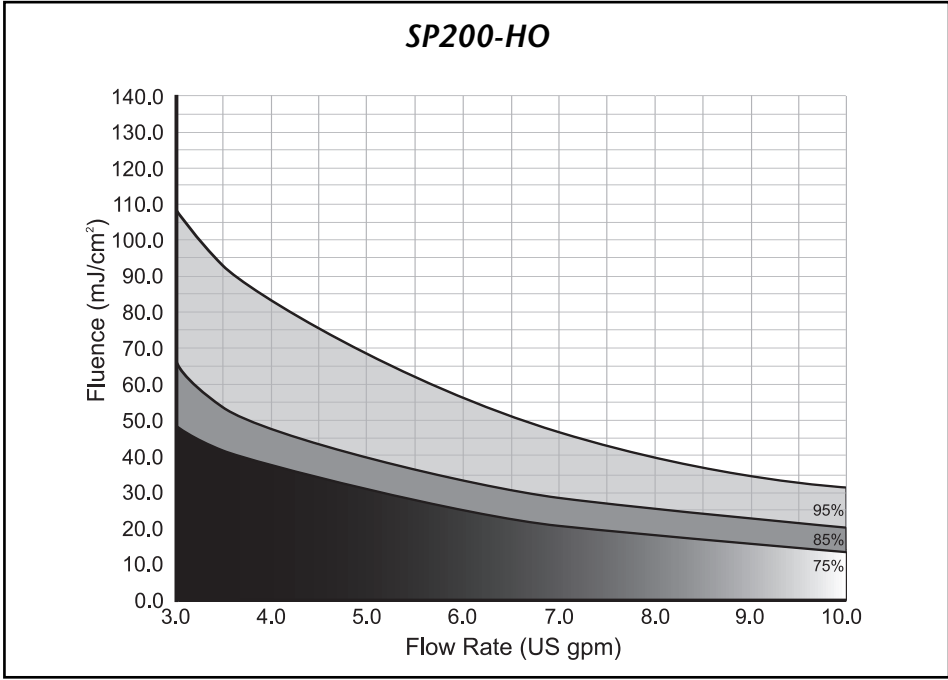
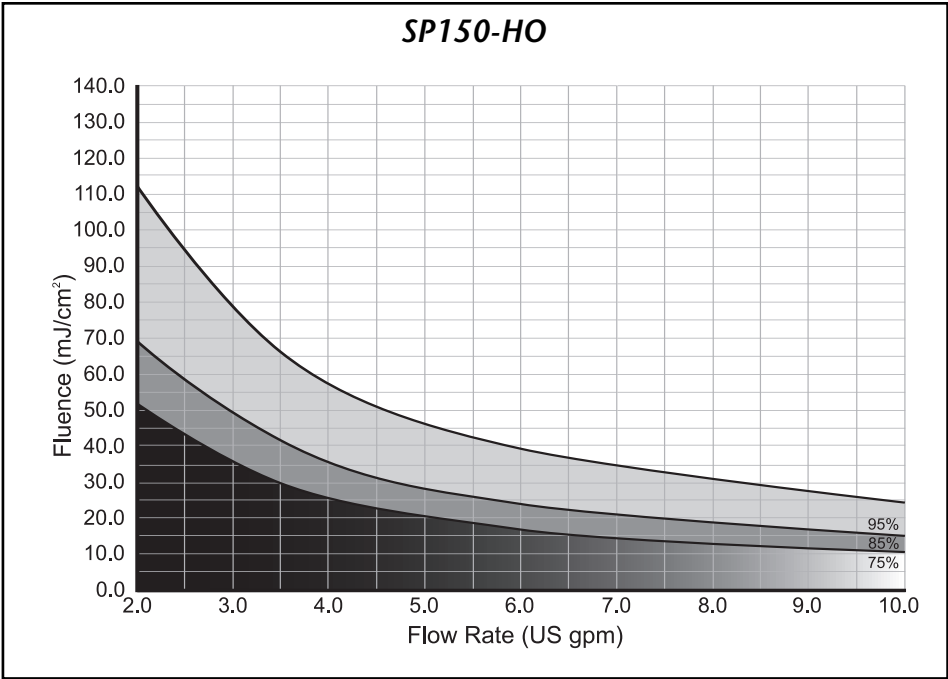

[ NOT PERFORMANCE TESTED OR CERTIFIED BY NSF ]

### SP320-HO

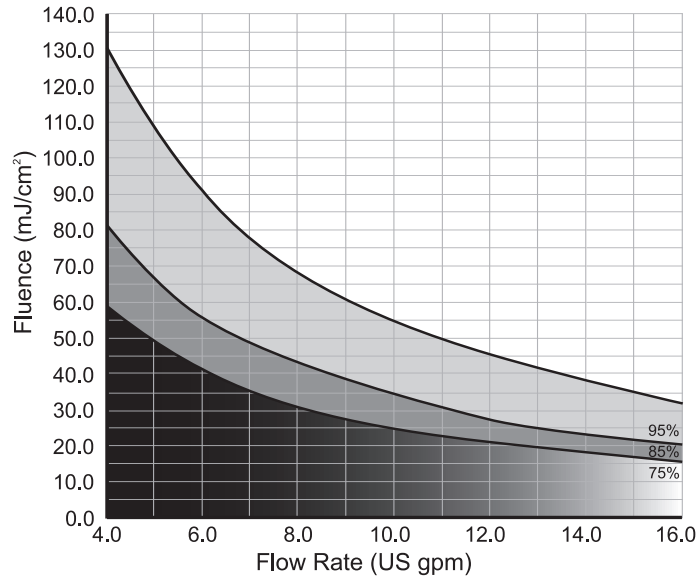

### SP410-HO

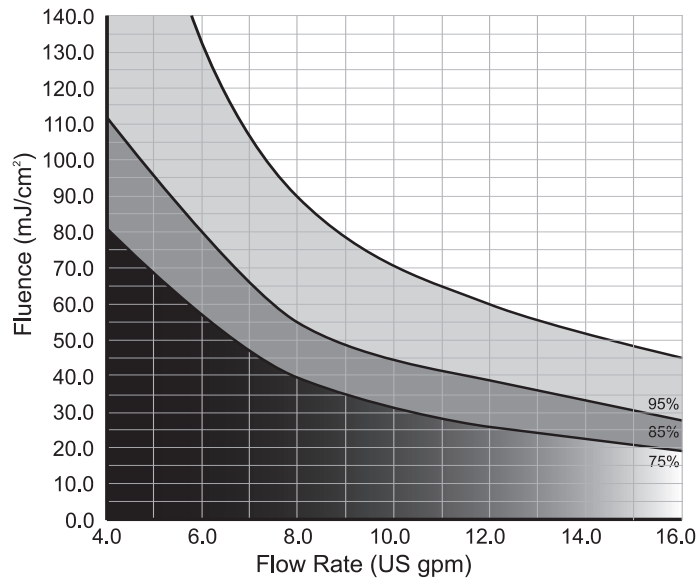

### SP600-HO

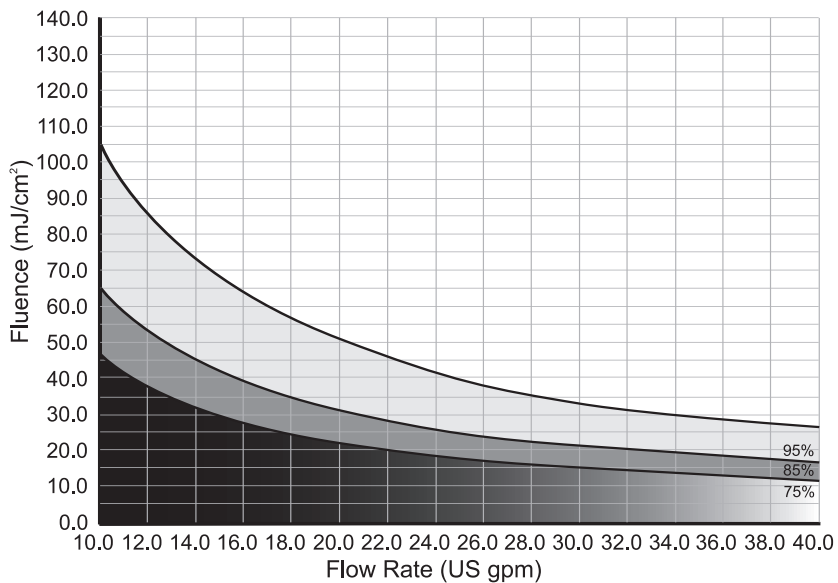

### SP740-HO

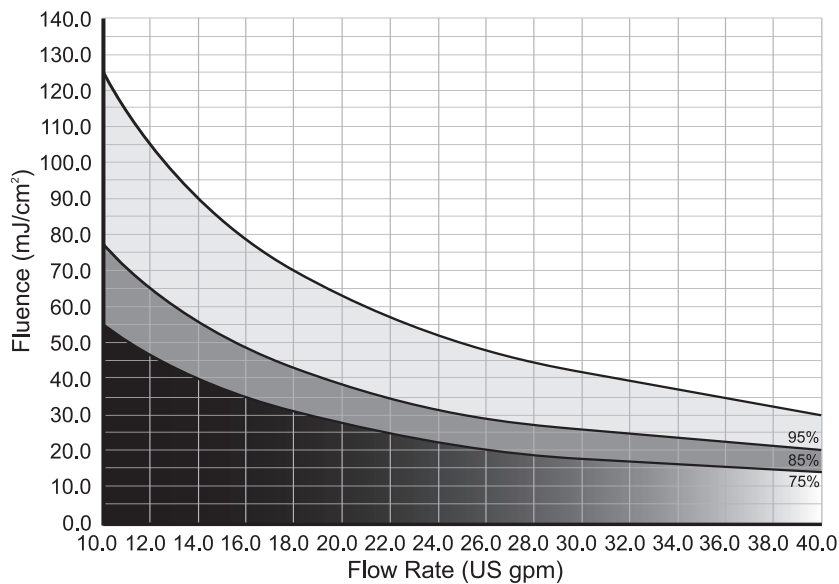

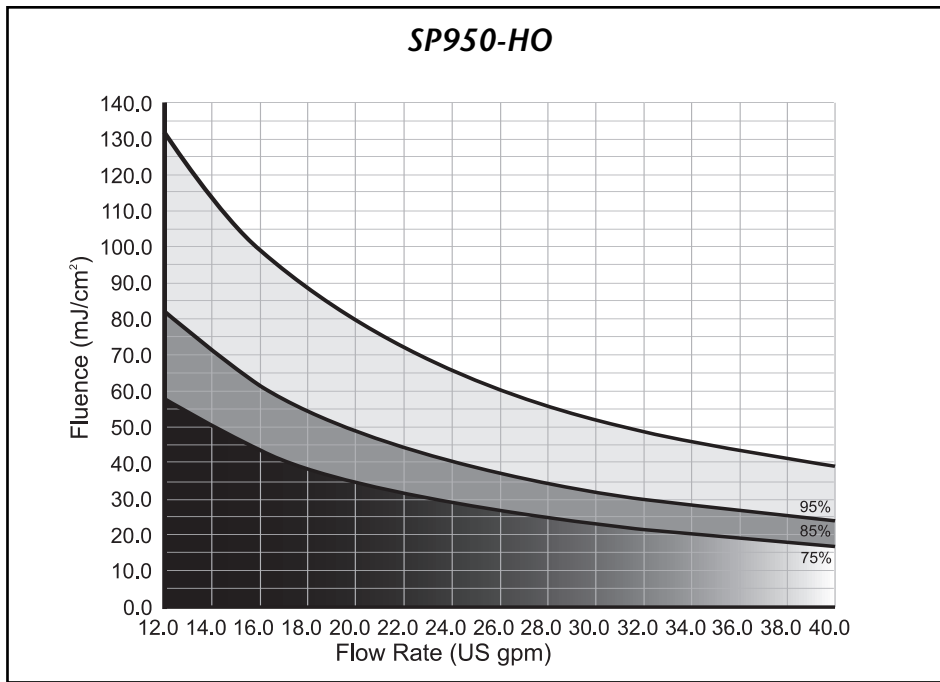

Once the UVT of the water is known, you must then decide on the level of disinfection that you feel is required for your particular situation. This is a critical decision and probably one of the most difficult decisions one needs to make when dealing with the selection of a UV system. Ultimately, it comes down to selecting what level of protection you are seeking for your water. Even though most micro-organisms found in water supplies of today are eradicated at extremely low UV levels (E. coli - 6.6 mJ/cm<sup>2</sup>, Shigella - 4.2 mJ/cm<sup>2</sup>, Giardia - <10 mJ/cm<sup>2</sup>, Cryptosporidium - <10 mJ/cm<sup>2</sup>) there are certain “emerging” pathogens that have shown up in some water supplies around the globe. Some of these pathogens, especially some viruses, may require higher levels of protection.

















Ultimately, you need to make the choice as to what level of protection you require for your specific application. The following are some levels that are currently being used in our industry.

FLUENCE (DOSE)	RATIONALIZATION
16 mJ/cm <sup>2</sup>	Original fluence level as proposed in the 1966 U.S. Public Health document concerning UV disinfection.
30 mJ/cm <sup>2</sup>	Currently the “Industry Standard” and a level of disinfection that R-Can has chosen to rate their systems at.
40 mJ/cm <sup>2</sup>	Current regulatory approach as indicated by: NSF/ANSI, EPA, DVGW, ÖNORM



# SPECIFICATIONS: [ NOT PERFORMANCE TESTED OR CERTIFIED BY NSF ]

DETAILED SPECS.

















Models		SP100-HO	SP150-HO	SP200-HO	SP320-HO	SP410-HO	SP600-HO	SP740-HO	SP950-HO
Rated Flow Rate @	16 ml/cm <sup>2</sup>	11 gpm <sup>1</sup> (41.6 lpm) (2.5 m <sup>3</sup> /hr.)	14 gpm <sup>1</sup> (53.0 lpm) (3.2 m <sup>3</sup> /hr.)	20 gpm <sup>1</sup> (75.7 lpm) (4.5 m <sup>3</sup> /hr.)	34 gpm <sup>1</sup> (128.7 lpm) (7.7 m <sup>3</sup> /hr.)	45 gpm <sup>1</sup> (170.3 lpm) (10.2 m <sup>3</sup> /hr.)	60 gpm <sup>1</sup> (227.1 lpm) (13.6 m <sup>3</sup> /hr.)	60 gpm <sup>1</sup> (227.1 lpm) (13.6 m <sup>3</sup> /hr.)	60 gpm <sup>1</sup> (227.1 lpm) (13.6 m <sup>3</sup> /hr.)
	30 ml/cm <sup>2</sup>	6 gpm <sup>1</sup> (22.7 lpm) (1.4 m <sup>3</sup> /hr.)	8 gpm <sup>1</sup> (30.3 lpm) (1.8 m <sup>3</sup> /hr.)	10 gpm <sup>1</sup> (37.9 lpm) (2.3 m <sup>3</sup> /hr.)	18 gpm <sup>1</sup> (68.1 lpm) (4.1 m <sup>3</sup> /hr.)	24 gpm <sup>1</sup> (90.8 lpm) (5.5 m <sup>3</sup> /hr.)	35 gpm <sup>1</sup> (132.5 lpm) (7.9 m <sup>3</sup> /hr.)	42 gpm <sup>1</sup> (158.9 lpm) (9.5 m <sup>3</sup> /hr.)	52 gpm <sup>1</sup> (196.8 lpm) (11.8 m <sup>3</sup> /hr.)
	40 ml/cm <sup>2</sup>	4 gpm <sup>1</sup> (15.1 lpm) (0.9 m <sup>3</sup> /hr.)	6 gpm <sup>1</sup> (22.7 lpm) (1.4 m <sup>3</sup> /hr.)	8 gpm <sup>1</sup> (30.3 lpm) (1.8 m <sup>3</sup> /hr.)	13 gpm <sup>1</sup> (49.2 lpm) (2.9 m <sup>3</sup> /hr.)	18 gpm <sup>1</sup> (68.1 lpm) (4.1 m <sup>3</sup> /hr.)	26 gpm <sup>1</sup> (98.4 lpm) (5.9 m <sup>3</sup> /hr.)	31 gpm <sup>1</sup> (117.3 lpm) (7.0 m <sup>3</sup> /hr.)	39 gpm <sup>1</sup> (147.6 lpm) (8.9 m <sup>3</sup> /hr.)
UV Intensity Monitor		yes	yes	yes	yes	yes	yes	yes	yes
Flow Pacing		yes	yes	yes	yes	yes	yes	yes	yes
Elapsed Time Meter	Countdown	yes	yes	yes	yes	yes	yes	yes	yes
	Total Hours	yes	yes	yes	yes	yes	yes	yes	yes
Flow Restrictor		no	no	no	no	no	no	no	no
Dry Contacts		yes	yes	yes	yes	yes	yes	yes	yes
Safety Interlock		yes	yes	yes	yes	yes	yes	yes	yes
Lamp Replacement Reminder		yes	yes	yes	yes	yes	yes	yes	yes
Diagnostic Check		yes	yes	yes	yes	yes	yes	yes	yes
Communication Port		yes	yes	yes	yes	yes	yes	yes	yes
Reactor Chamber Material		304 SS	304 SS	304 SS	304 SS	304 SS	304 SS	304 SS	304 SS
Electropolished & Passivated		no	no	no	no	no	no	no	no
Electrical	Volts	90-265V./ 50-60Hz.	90-265V./ 50-60Hz.	90-265V./ 50-60Hz.	90-265V./ 50-60Hz.	90-265V./ 50-60Hz.	90-265V./ 50-60Hz.	90-265V./ 50-60Hz.	90-265V./ 50-60Hz.
	Power Consumption	20 W	25 W	35 W	42 W	52 W	73 W	88 W	110 W
	Lamp Watts	15 W	20 W	30 W	36 W	45 W	65 W	80 W	100 W
Maximum Operating Pressure		8.62 bar (125 psi)	8.62 bar (125 psi)	8.62 bar (125 psi)	8.62 bar (125 psi)	8.62 bar (125 psi)	8.62 bar (125 psi)	8.62 bar (125 psi)	8.62 bar (125 psi)
Pressure Drop at Rated Flow		<b>SEE CHART ON PAGE 22</b>							
Ambient Water Temperature		2-40°C (36-104°F)	2-40°C (36-104°F)	2-40°C (36-104°F)	2-40°C (36-104°F)	2-40°C (36-104°F)	2-40°C (36-104°F)	2-40°C (36-104°F)	2-40°C (36-104°F)
Maximum Ambient Temperature		50°C (122°F)	50°C (122°F)	50°C (122°F)	50°C (122°F)	50°C (122°F)	50°C (122°F)	50°C (122°F)	50°C (122°F)
Dimensions	Reactor	13.8" x 3.5" (351 x 89 mm)	15.8" x 3.5" (401 x 89 mm)	17.8" x 3.5" (452 x 89 mm)	22.8" x 3.5" (580 x 89 mm)	26.4" x 3.5" (670 x 89 mm)	33.9" x 3.5" (860 x 89 mm)	39.4" x 3.5" (1000 x 89 mm)	47.6" x 3.5" (1210 x 89 mm)
	Controller	10.75" x 4.5" x 2" (254 x 114 x 53 mm)	10.75" x 4.5" x 2" (254 x 114 x 53 mm)	10.75" x 4.5" x 2" (254 x 114 x 53 mm)	10.75" x 4.5" x 2" (254 x 114 x 53 mm)	10.75" x 4.5" x 2" (254 x 114 x 53 mm)	10.75" x 4.5" x 2" (254 x 114 x 53 mm)	10.75" x 4.5" x 2" (254 x 114 x 53 mm)	10.75" x 4.5" x 2" (254 x 114 x 53 mm)
Shipping Weight		10 lbs (4.5 kg)	11 lbs (5 kg)	12 lbs (5.4 kg)	14 lbs (6.4 kg)	15 lbs (6.8 kg)	18 lbs (8.2 kg)	19 lbs (8.6 kg)	20 lbs (9.1 kg)
Inlet/Outlet Port Size		Combo 3/4" FNPT/ 1" MNPT	Combo 3/4" FNPT/ 1" MNPT	Combo 3/4" FNPT/ 1" MNPT	1" MNPT	1" MNPT	1" MNPT	1" MNPT	1" MNPT
NSF/ANSI Standard 55 Class A Validation		no	no	no	no	no	no	no	no
Other Approvals**		 	 	 	 	 	 	 	 

1. Flow rates stated at 95% UVT<sub>10</sub>

2. Flow Rate dictated by maximum pressure drop (>8psi)



# SPECIFICATIONS:

Models		SPV-1.5	SPV-2.5	SPV-3.5	SPV-6	SPV-8	SPV-12	SPV-15	SPV-20
<b>Flow Rate</b>									
<b>40 ml/cm<sup>2</sup></b>		1.5 gpm' (5.9 lpm) (0.3 m <sup>3</sup> /hr.)	2.5 gpm' (9.5 lpm) (0.6 m <sup>3</sup> /hr.)	3.5 gpm' (13.2 lpm) (0.8 m <sup>3</sup> /hr.)	6 gpm' (22.7 lpm) (1.4 m <sup>3</sup> /hr.)	8 gpm' (30.3 lpm) (1.8 m <sup>3</sup> /hr.)	12 gpm' (45.4 lpm) (2.7 m <sup>3</sup> /hr.)	15 gpm' (56.8 lpm) (3.4 m <sup>3</sup> /hr.)	20 gpm' (75.7 lpm) (4.5 m <sup>3</sup> /hr.)
<b>UV Intensity Monitor</b>		yes	yes	yes	yes	yes	yes	yes	yes
<b>Flow Pacing</b>		yes	yes	yes	yes	yes	yes	yes	yes
<b>Elapsed Time Meter</b>	<b>Countdown</b>	yes	yes	yes	yes	yes	yes	yes	yes
	<b>Total Hours</b>	yes	yes	yes	yes	yes	yes	yes	yes
<b>Flow Restrictor</b>		yes	yes	yes	yes	yes	yes	yes	yes
<b>Dry Contacts</b>		yes	yes	yes	yes	yes	yes	yes	yes
<b>Safety Interlock</b>		yes	yes	yes	yes	yes	yes	yes	yes
<b>Lamp Replacement Reminder</b>		yes	yes	yes	yes	yes	yes	yes	yes
<b>Diagnostic Check</b>		yes	yes	yes	yes	yes	yes	yes	yes
<b>Communication Port</b>		yes	yes	yes	yes	yes	yes	yes	yes
<b>Reactor Chamber Material</b>		316 L SS	316 L SS	316 L SS	316 L SS	316 L SS	316 L SS	316 L SS	316 L SS
<b>Electropolished &amp; Passivated</b>		yes	yes	yes	yes	yes	yes	yes	yes
<b>Electrical</b>	<b>Volts</b>	90-265V./ 50-60Hz.	90-265V./ 50-60Hz.	90-265V./ 50-60Hz.	90-265V./ 50-60Hz.	90-265V./ 50-60Hz.	90-265V./ 50-60Hz.	90-265V./ 50-60Hz.	90-265V./ 50-60Hz.
	<b>Power Consumption</b>	20 W	25 W	35 W	42 W	52 W	73 W	88 W	110 W
	<b>Lamp Watts</b>	15 W	20 W	30 W	36 W	45 W	65 W	80 W	100 W
<b>Maximum Operating Pressure</b>		8.62 bar (125 psi)	8.62 bar (125 psi)	8.62 bar (125 psi)	8.62 bar (125 psi)	8.62 bar (125 psi)	8.62 bar (125 psi)	8.62 bar (125 psi)	8.62 bar (125 psi)
<b>Minimum Operating Pressure</b>		1bar (14.5 psi)	1bar (14.5 psi)	1bar (14.5 psi)	1bar (14.5 psi)	1bar (14.5 psi)	1bar (14.5 psi)	1bar (14.5 psi)	1bar (14.5 psi)
<b>Pressure Drop at Rated Flow</b>		<b>SEE CHART ON PAGE 22</b>							
<b>Ambient Water Temperature</b>		2-40°C (36-104°F)	2-40°C (36-104°F)	2-40°C (36-104°F)	2-40°C (36-104°F)	2-40°C (36-104°F)	2-40°C (36-104°F)	2-40°C (36-104°F)	2-40°C (36-104°F)
<b>Maximum Ambient Temperature</b>		50°C (122°F)	50°C (122°F)	50°C (122°F)	50°C (122°F)	50°C (122°F)	50°C (122°F)	50°C (122°F)	50°C (122°F)
<b>Dimensions</b>	<b>Reactor</b>	13.8" x 3.5" (351 x 89 mm)	15.8" x 3.5" (401 x 89 mm)	17.8" x 3.5" (452 x 89 mm)	22.8" x 3.5" (580 x 89 mm)	26.4" x 3.5" (670 x 89 mm)	33.9" x 3.5" (860 x 89 mm)	39.4" x 3.5" (1000 x 89 mm)	47.6" x 3.5" (1210 x 89 mm)
	<b>Controller</b>	10.75" x 4.5" x 2" (254 x 114 x 53 mm)	10.75" x 4.5" x 2" (254 x 114 x 53 mm)	10.75" x 4.5" x 2" (254 x 114 x 53 mm)	10.75" x 4.5" x 2" (254 x 114 x 53 mm)	10.75" x 4.5" x 2" (254 x 114 x 53 mm)	10.75" x 4.5" x 2" (254 x 114 x 53 mm)	10.75" x 4.5" x 2" (254 x 114 x 53 mm)	10.75" x 4.5" x 2" (254 x 114 x 53 mm)
<b>Shipping Weight</b>		11 lbs (5 kg)	11 lbs (5 kg)	12 lbs (5.4 kg)	14 lbs (6.4 kg)	15 lbs (6.8 kg)	18 lbs (8.2 kg)	19 lbs (8.6 kg)	21 lbs (9.5 kg)
<b>Inlet/Outlet Port Size</b>		1/2" MNPT	1/2" MNPT	1/2" MNPT	Combo 3/4" FNPT/ 1" MNPT	Combo 3/4" FNPT/ 1" MNPT	Combo 3/4" FNPT/ 1" MNPT	Combo 3/4" FNPT/ 1" MNPT	Combo 3/4" FNPT/ 1" MNPT
<b>NSF/ANSI Standard 55 Class A Validation</b>		yes	yes	yes	yes	yes	yes	yes	yes
<b>Other Certifications</b>		 	 	 	 	 	 	 	 

1. Flow rates stated as determined by NSF/ANSI Standard 55 testing.

**Platinum SPV Series (with flow regulator):  
Pressure Drop vs. Flow Rate\***

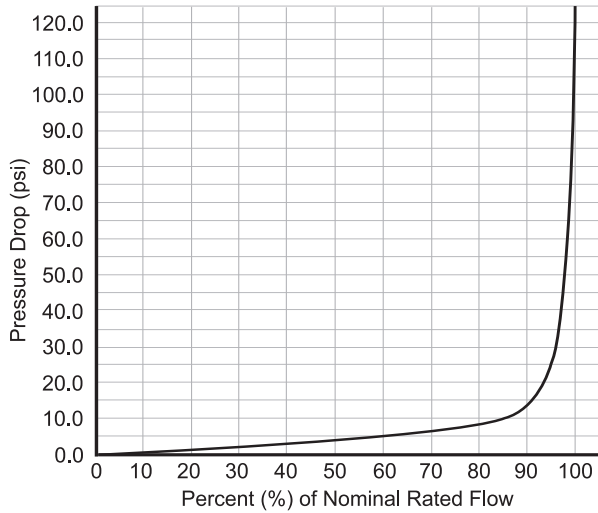

\* Due to the nature of flow regulators, actual flow may be up to 12% less than nominal at any specific pressure.

*(Note: This chart applies to NSF certified models)*

**Platinum SP Series with 1/2" NPT Ports  
(without flow regulators)  
Pressure vs. Flow Rate\***

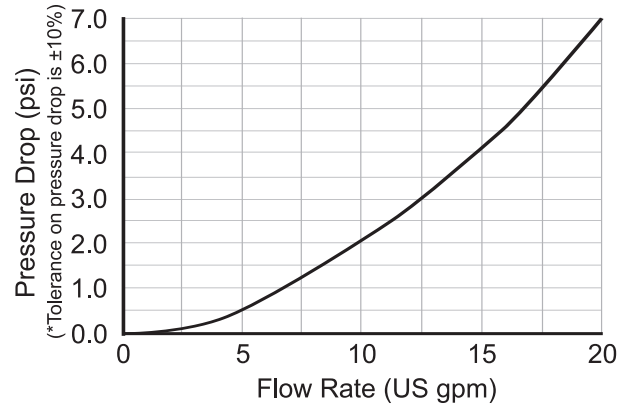

**[ NOT PERFORMANCE TESTED OR CERTIFIED BY NSF ]**

**Platinum SP Series with 1" NPT Ports  
(without flow regulators)  
Pressure vs. Flow Rate\***

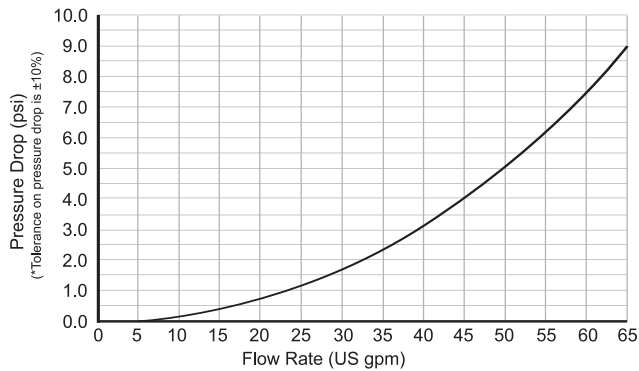

**[ NOT PERFORMANCE TESTED OR CERTIFIED BY NSF ]**

**Platinum SP Series with 1"-3/4" NPT Combo Ports  
(without flow regulators)  
Pressure vs. Flow Rate\***

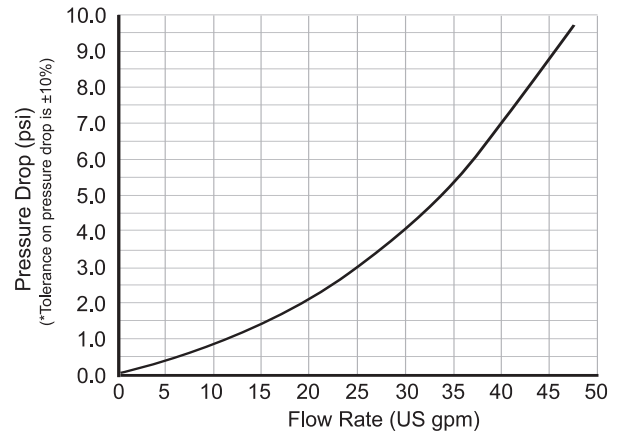

**[ NOT PERFORMANCE TESTED OR CERTIFIED BY NSF ]**

# WARRANTY:

## MANUFACTURER'S WARRANTY

Manufacturer warrants the ultraviolet disinfection systems hardware and electrical systems to be free from defects in material and workmanship for a period of five (5) years from the date of purchase by the original owner (consumer) on a pro-rated basis. Manufacturer warrants the ultraviolet lamps and sensor probes to be free from defects in material and workmanship for a period of one (1) year and the reactor chamber for a period of seven (7) years. The Warrantor will at its option and expense, either repair or replace such units subject to the following conditions, exceptions, and exclusions. No other warranties with respect to the units other than those expressly included in this one year warranty, have been made by the Warrantor.

## CONDITIONS, EXCEPTIONS, AND EXCLUSIONS

*The foregoing limited warranty is subject to the following terms and conditions:*

1. Water passed through the unit must fall within the following parameters:

- a) Iron: < 0.3 ppm (0.3 mg/L)
- b) Hardness\*: < 7 gpg (120 mg/L)
- c) Turbidity: < 1 NTU
- d) Manganese: < 0.05 ppm (0.05 mg/L)
- e) Tannins: < 0.1 ppm (0.1 mg/L)
- f) UV Transmittance: > 75% (call factory for recommendations on applications where UVT < 75%)

*\* Where total hardness is less than 7 gpg, the UV unit should operate efficiently provided the quartz sleeve and/or sensor probe is cleaned periodically. If total hardness is over 7 gpg, the water should be softened.*

***Warranty will be void, if the proper steps are not taken to ensure that these impurities are not present.***

2. This limited warranty shall not apply to any unit which has been repaired or altered by anyone other than the Warrantor or by a person authorized by the Warrantor, nor to any units which have been subject to misuse, neglect, or accident.
3. This limited warranty runs exclusively to the original consumer and with respect to the original installation only.
4. WARRANTOR SHALL NOT BE LIABLE FOR ANY INCIDENTAL OR CONSEQUENTIAL DAMAGES.
5. This limited warranty excludes the cost of labour in removing any defective unit or installing any replacement unit. This limited Warranty applies only to a unit when returned to the Warrantor at the owner's expense and in accordance with shipping instructions received from the Warrantor.



## DO NOT CONSUME THE WATER

The system has been placed on by-pass and as a result the water in this distribution system should not be consumed until the system has been fully sanitized and returned to service. Please refer to the Installation Manual for complete disinfection procedure.



Place  
Stamp  
Here

### Warranty Department

P.O. BOX 1719  
GUELPH, ONTARIO  
N1H 6Z9



425 Clair Road West  
Guelph, ON N1L 1R1 Canada  
t. 519.763.1032 • t.f. 1.800.265.7246 • f. 519.763.5069  
e. [water@r-can.com](mailto:water@r-can.com) • i. [www.r-can.com](http://www.r-can.com)



IMPORTANT NOTICE  
This card must be returned within (10) days of purchase to register your warranty.  
PLEASE PRINT Thank you.

Model No. \_\_\_\_\_  
(Must Specify)

Your Name: \_\_\_\_\_ E-mail Address: \_\_\_\_\_ DATE OF PURCHASE: Mo. \_\_\_\_\_ Yr. \_\_\_\_\_

Address: \_\_\_\_\_  
Street City Prov./State & Postal Code/Zip

Telephone Number: (\_\_\_\_) \_\_\_\_\_

Dealer's Name: \_\_\_\_\_

Dealer's Address: \_\_\_\_\_  
Street City Prov./State & Postal Code/Zip

1. Where is this unit to be used?

- A  Apartment    B  Home    C  Farm    D  Motel/Hotel    E  Cottage    F  Boat
- G  Condo    H  Business    I  Trailer/Mobile    J  Restaurant    K  Coffee Service    L  Institutional Kitchen
- M  Vending Machine    N  Convenience Store    O  Other (specify) \_\_\_\_\_

2. What type of store was this unit purchased?

- A  Plumbing    B  Hardware    C  Farm    D  Water Treatment    E  Lumber/Home Centre    F  Department Store
- G  RV Sales    H  Food Service Sales    I  Vending Supply    J  Other (specify) \_\_\_\_\_

3. What attracted your attention to this unit?

- A  Store Display    B  Newspaper Ad    C  Magazine Ad    D  Catalogue    E  Plumber's Recommendation
- F  Friend's Recommendation    G  Yellow Pages    H  Other (specify) \_\_\_\_\_

4. Equipment installed primarily to treat?

- A  Dirt    B  Rust    C  Algae    D  Chlorine Taste or Odour    E  Sulphur Taste or Odour    F  Iron
- G  Hard Water/Scale    H  Corrosion    I  Chemicals    J  Microbiological Contaminants    K  Pool/Spa Treatment    L  Other (specify) \_\_\_\_\_

5. Filtered water needed primarily

- A  Drinking    B  Beverages    C  Cooking    D  Laundry    E  Health or Medical Reasons
- F  Shower/Bath    G  Toilet    H  Ice Machine    I  Coffee    J  Post Mix
- K  Vending Machine    L  Humidifier    M  Other (specify) \_\_\_\_\_

6. What is your water source?

- A  Public    B  Community Well    C  Your Own Well    D  Lake/River    E  Cistern    F  Other (specify) \_\_\_\_\_

7. Do you have any other water treatment products? (specify)

\_\_\_\_\_

8. Who installed your unit?

- A  Yourself    B  Plumber    C  Other

9. Unit purchase price \_\_\_\_\_ Installation cost \_\_\_\_\_

- 10. Do you have, or use, bottled water?    A  Yes    B  No
- 11. Was this unit purchased to replace bottled water?    A  Yes    B  No

serial number required for warranty



425 Clair Road West  
Guelph, ON N1L 1R1  
Canada

t. 519.763.1032  
t.f. 1.800.265.7246  
f. 519.763.5069  
e. water@r-can.com  
i. www.r-can.com

ensuring the safety of your water



System Tested and  
Certified by NSF  
International against  
NSF/ANSI  
Standard 55 for  
Disinfection Performance,  
Class A.

This Class A system conforms to NSF/ANSI 55 for the disinfection of microbiologically contaminated water that meets all other public health standards. The system is not intended to convert wastewater or raw sewage to drinking water. The system is intended to be installed on visually clear water.

NSF/ANSI 55 defines wastewater to include human and/or animal body waste, toilet paper, and any other material intended to be deposited in a receptacle designed to receive urine and/or feces (black-waste); and other waste materials deposited in plumbing fixtures (grey-waste).

If this system is used for the treatment of untreated surface waters or ground water under the direct influence of surface water, a device found to be in conformance for cyst reduction under the appropriate NSF/ANSI Standard shall be installed upstream of the system.

Note: NSF Information pertains only to the  
SPV-1.5, SPV-2.5, SPV-3.5, SPV-6, SPV-8,  
SPV-12, SPV-15 and SPV-20 models



EPA # 57987-CN-001

revised January 2006 - P/N 520066