

FILTER

WATER FILTER

Filter Reset: When the filter icon turns on, you have to change the water filter. Press the Filter button for 3 seconds to turn the icon off.



Before removing or installing water filter:

- **IMPORTANT:** Turn off household water supply.
- Take out the top shelf and move it to the lowest level.

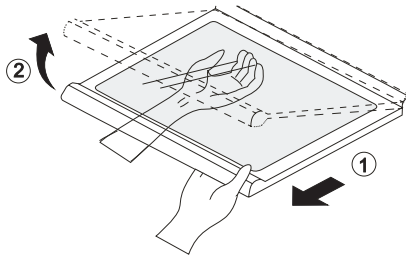

Removing the Water Filter

- Remove old filter by turning it counterclockwise a quarter turn and pulling it down. The substitute cap must be retained for the future. If the filter is removed and not replaced, it is necessary to reinstall the substitute cap to prevent water leaks from the filter housing.

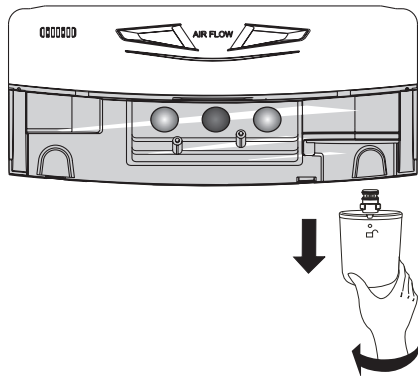

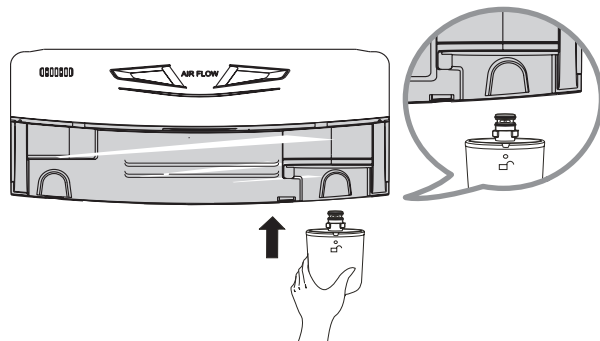

Installing the Water Filter

- Remove the red cap from the filter.
- Hold the filter with the unlock symbol  facing towards you as shown in the figure below. Insert the filter into the filter receptacle on the right side of the refrigerator compartment.

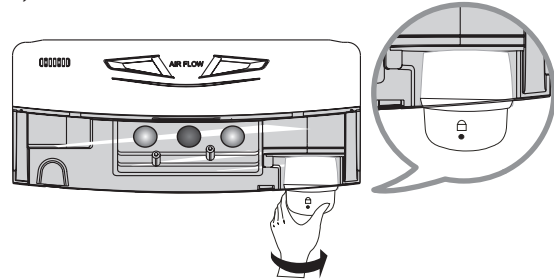

- Push the water filter up into the filter receptacle and rotate it clockwise to lock it into place. Once installed correctly, the lock symbol  should be facing you and you should not be able to rotate the filter clockwise anymore.



NOTE: After installation, if you notice that the lock symbol  is not facing you or you can continue to rotate the filter clockwise; remove the filter and repeat installation to prevent water leaks.

After installing the Water Filter

- Replace the shelf to the initial position.
- After installing filter, turn on household water supply.
- Dispense 2,5 gallons (9,46 liters) of water to purge the system, depressing and releasing the dispenser pad in cycles of 30 seconds ON and 60 seconds OFF. Open the refrigerator door and check the shelf area for water leaks.

To purchase or replace water filters, call your Service Center. Refer to the Warranty Card to obtain the telephone number of the Service Center near you and ask for part no. 5231JA2002A or ADQ72910901.