



Storm Café

Water and Coffee Dispenser User Manual



CAUTION: Unit must be stored in an environment where the temperature will not drop below freezing (32° F/0° C). Failure to do so may result in damage to the unit.



1. Coffee Pod Holder

- Top part of Coffee Pod Holder
- Bottom part of Coffee Pod Holder

2. Brew Selection Panel

- 6 oz button
- 8 oz button
- 10 oz button
- Brew button

3. Indicator Lights

- Blue (Top) – Replace SmartFlo™ Water Cartridge
- Blue (Bottom) – Replace Bottle

4. Hot Water Lever

(with child resistant feature)

5. LED Nightlight

- Left side 7pcs LED(LED1~LED7), night led/indicator dispense hot water
- Right side 7pcs LED(LED8~LED14), night led/indicator dispense cold water

6. Coffee and Water Outlet

7. Cold Water Lever

8. Raised Drip Tray

9. Drip Tray Base and Cover

10. Hot Tank Power Switch

11. Bottle Adaptor Assembly

12. Water Bottle (Not included)

• Due to continuous improvement, product may not appear exactly as shown

Coffee Brewer Detail



Coffee Pod Brewer Assembly



Opened to Show Pod Holder



Beverage Outlet tubes: (L to R) Hot Water, Coffee, Cold Water

Coffee Pod Dimensions

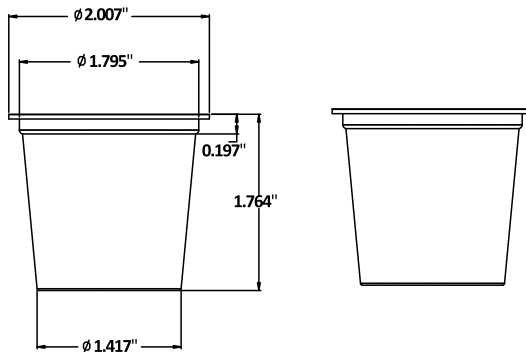

CAUTION

This unit dispenses water at temperatures that can cause severe burns.

Children should be supervised to ensure that they do not play with the appliance.

This appliance is not intended for use by persons (including children) with reduced physical, sensory or mental capabilities, or lack of experience and knowledge, unless they have been given supervision or instruction concerning use of the appliance by a person responsible for their safety.

- Due to continuous improvement, product may not appear exactly as shown

Single service Keurig brand K-Cup® Pod

K-Cup is a trademark of Keurig Green Mountain, Inc., used with permission

Category	Brand	Description
K-Cup® Pod	Barista Prima Coffeehouse®	Barista Prima Coffeehouse® Colombia Coffee, 24ct
K-Cup® Pod	Barista Prima Coffeehouse®	Barista Prima Coffeehouse® Decaf Italian Roast, 24ct
K-Cup® Pod	Barista Prima Coffeehouse®	Barista Prima Coffeehouse® Espresso Roast, 24ct
K-Cup® Pod	Barista Prima Coffeehouse®	Barista Prima Coffeehouse® French Roast, 24ct
K-Cup® Pod	Barista Prima Coffeehouse®	Barista Prima Coffeehouse® Italian Roast, 24ct
K-Cup® Pod	Bigelow®	Bigelow® Earl Grey Tea, 24ct
K-Cup® Pod	Bigelow®	Bigelow® English Breakfast Tea, 24ct
K-Cup® Pod	Bigelow®	Bigelow® Green Tea, 24ct
K-Cup® Pod	Bigelow®	Bigelow® Stay Well® Herbal Tea, 22ct
K-Cup® Pod	Bigelow®	Bigelow® Tropical Iced Green Tea, 22ct
K-Cup® Pod	BLK & BOLD®	BLK & BOLD® Brighter Days, 20 ct
K-Cup® Pod	BLK & BOLD®	BLK & BOLD® Rise & GRND, 20 ct
K-Cup® Pod	BLK & BOLD®	BLK & BOLD® Smooove Operator, 20 ct
K-Cup® Pod	Café Bustelo®	Café Bustelo® 100% Colombian Coffee, 24ct
K-Cup® Pod	Café Bustelo®	Café Bustelo® Espresso Style Coffee, 24ct
K-Cup® Pod	Café Bustelo®	Café Bustelo® Café con Leche, 24ct
K-Cup® Pod	Café Escapes®	Café Escapes® Café Caramel, 24ct
K-Cup® Pod	Café Escapes®	Café Escapes® Café Mocha, 24ct
K-Cup® Pod	Café Escapes®	Café Escapes® Café Vanilla, 24ct
K-Cup® Pod	Café Escapes®	Café Escapes® Chai Latte, 24ct
K-Cup® Pod	Café Escapes®	Café Escapes® Dark Chocolate Hot Cocoa, 24ct
K-Cup® Pod	Café Escapes®	Café Escapes® Milk Chocolate Hot Cocoa, 24ct
K-Cup® Pod	Caribou Coffee®	Caribou Coffee® Caramel Hideaway, 24ct
K-Cup® Pod	Caribou Coffee®	Caribou Coffee® Caribou Blend Decaf, 24ct
K-Cup® Pod	Caribou Coffee®	Caribou Coffee® Caribou Blend, 24ct
K-Cup® Pod	Caribou Coffee®	Caribou Coffee® Daybreak Blend, 24ct
K-Cup® Pod	Caribou Coffee®	Caribou Coffee® Lakeshore Blend, 24ct
K-Cup® Pod	Caribou Coffee®	Caribou Coffee® Mahogany, 24ct
K-Cup® Pod	Caribou Coffee®	Caribou Coffee® Obsidian, 24ct
K-Cup® Pod	Caribou Coffee®	Caribou Coffee® Reindeer Blend, 22ct
K-Cup® Pod	Caribou Coffee®	Caribou Coffee® BOU YAH, 22ct
K-Cup® Pod	Celestial Seasonings®	Celestial Seasonings® Decaf Green Tea, 24ct
K-Cup® Pod	Celestial Seasonings®	Celestial Seasonings® English Breakfast Tea, 24ct
K-Cup® Pod	Celestial Seasonings®	Celestial Seasonings® India Spice Chai, 24ct
K-Cup® Pod	Celestial Seasonings®	Celestial Seasonings® Mandarin Orange Spice Tea, 24ct
K-Cup® Pod	Celestial Seasonings®	Celestial Seasonings® Green Tea, 24ct
K-Cup® Pod	Celestial Seasonings®	Celestial Seasonings® Sleepytime Herbal Tea, 24ct
K-Cup® Pod	Cinnabon®	Cinnabon® Caramel Pecan, 24ct
K-Cup® Pod	Cinnabon®	Cinnabon® Classic Cinnamon Roll Coffee, 24ct
K-Cup® Pod	Community Coffee®	Community Coffee® Breakfast Blend Coffee, 24ct
K-Cup® Pod	Community Coffee®	Community Coffee® Café Special Coffee, 24ct
K-Cup® Pod	Community Coffee®	Community Coffee® Café Special Decaf Coffee, 24ct
K-Cup® Pod	Community Coffee®	Community Coffee® Coffee & Chicory Coffee, 24ct
K-Cup® Pod	Community Coffee®	Community Coffee® Signature Blend Coffee, 24ct
K-Cup® Pod	Dunkin'®	Dunkin'® Caramel Me Crazy, 22ct
K-Cup® Pod	Dunkin'®	Dunkin'® Decaf, 22ct
K-Cup® Pod	Dunkin'®	Dunkin'® Midnight, 22ct
K-Cup® Pod	Dunkin'®	Dunkin'® Espresso Style, 22ct
K-Cup® Pod	Dunkin'®	Dunkin'® French Vanilla, 22ct
K-Cup® Pod	Dunkin'®	Dunkin'® Hazelnut, 22ct

K-Cup® Pod	Dunkin®	Dunkin® Milk Chocolate Hot Cocoa, 22ct
K-Cup® Pod	Dunkin®	Dunkin® Original Blend, 22ct
K-Cup® Pod	Dunkin®	Dunkin® Polar Peppermint, 22ct
K-Cup® Pod	Dunkin®	Dunkin® Turtle Love, 22ct
K-Cup® Pod	Dunkin®	Dunkin® COLD, 22ct
K-Cup® Pod	Dunkin®	Dunkin® COLD Caramel, 22ct
K-Cup® Pod	Eight O'Clock®	Eight O'Clock® Coffee Colombian Peaks, 24ct
K-Cup® Pod	Eight O'Clock®	Eight O'Clock® Coffee Dark Italian Roast, 24ct
K-Cup® Pod	Eight O'Clock®	Eight O'Clock® Coffee Hazelnut, 24ct
K-Cup® Pod	Eight O'Clock®	Eight O'Clock® Coffee The Original Decaf, 24ct
K-Cup® Pod	Eight O'Clock®	Eight O'Clock® Coffee The Original, 24ct
K-Cup® Pod	Emeril's®	Emeril's® Big Easy Bold, 24ct
K-Cup® Pod	Folgers®	Folgers® 100% Colombian Coffee, 24ct
K-Cup® Pod	Folgers®	Folgers® 100% Colombian Decaf Coffee, 24ct
K-Cup® Pod	Folgers®	Folgers® Black Silk, 24ct
K-Cup® Pod	Folgers®	Folgers® Breakfast Blend, 24ct
K-Cup® Pod	Folgers®	Folgers® Buttery Caramel, 24ct
K-Cup® Pod	Folgers®	Folgers® Classic Roast, 24ct
K-Cup® Pod	Folgers®	Folgers® Toasty Hazelnut, 24ct
K-Cup® Pod	Folgers®	Folgers® French Vanilla, 24ct
K-Cup® Pod	GEVALIA	GEVALIA Colombia, 24ct
K-Cup® Pod	GEVALIA	GEVALIA Dark Royal Roast, 24ct
K-Cup® Pod	GEVALIA	GEVALIA Signature Blend, 24ct
K-Cup® Pod	Gloria Jean's®	Gloria Jean's® Butter Toffee, 24ct
K-Cup® Pod	Gloria Jean's®	Gloria Jean's® Hazelnut, 24ct
K-Cup® Pod	Gloria Jean's®	Gloria Jean's® Raspberry Chocolate Lava, 24ct
K-Cup® Pod	Gloria Jean's®	Gloria Jean's® French Vanilla Supreme, 24ct
K-Cup® Pod	Gloria Jean's®	Gloria Jean's® Macadamia Cookie, 24ct
K-Cup® Pod	Green Mountain Coffee Roasters®	Green Mountain Coffee Roasters® Black Granite, 24ct
K-Cup® Pod	Green Mountain Coffee Roasters®	Green Mountain Coffee Roasters® Breakfast Blend Decaf, 24ct
K-Cup® Pod	Green Mountain Coffee Roasters®	Green Mountain Coffee Roasters® Breakfast Blend, 24ct
K-Cup® Pod	Green Mountain Coffee Roasters®	Green Mountain Coffee Roasters® Brown Sugar Crumble, 24ct
K-Cup® Pod	Green Mountain Coffee Roasters®	Green Mountain Coffee Roasters® Caramel Vanilla Cream, 24ct
K-Cup® Pod	Green Mountain Coffee Roasters®	Green Mountain Coffee Roasters® Chocolate Dipped Pistachio, 24ct
K-Cup® Pod	Green Mountain Coffee Roasters®	Green Mountain Coffee Roasters® Cinnamon Honey Drizzle, 24ct
K-Cup® Pod	Green Mountain Coffee Roasters®	Green Mountain Coffee Roasters® Cinnamon Sugar Cookie, 24ct
K-Cup® Pod	Green Mountain Coffee Roasters®	Green Mountain Coffee Roasters® Colombia Select, 24ct
K-Cup® Pod	Green Mountain Coffee Roasters®	Green Mountain Coffee Roasters® Costa Rica Paraiso, 24ct
K-Cup® Pod	Green Mountain Coffee Roasters®	Green Mountain Coffee Roasters® Dark Magic Decaf, 24ct
K-Cup® Pod	Green Mountain Coffee Roasters®	Green Mountain Coffee Roasters® Dark Magic, 24ct
K-Cup® Pod	Green Mountain Coffee Roasters®	Green Mountain Coffee Roasters® Double Diamond, 24ct
K-Cup® Pod	Green Mountain Coffee Roasters®	Green Mountain Coffee Roasters® Ethiopia Supreme Coffee, 24ct
K-Cup® Pod	Green Mountain Coffee Roasters®	Green Mountain Coffee Roasters® French Roast, 24ct
K-Cup® Pod	Green Mountain Coffee Roasters®	Green Mountain Coffee Roasters® French Vanilla Decaf, 24ct
K-Cup® Pod	Green Mountain Coffee Roasters®	Green Mountain Coffee Roasters® French Vanilla, 24ct
K-Cup® Pod	Green Mountain Coffee Roasters®	Green Mountain Coffee Roasters® Half Caff, 24ct
K-Cup® Pod	Green Mountain Coffee Roasters®	Green Mountain Coffee Roasters® Hazelnut Decaf, 24ct
K-Cup® Pod	Green Mountain Coffee Roasters®	Green Mountain Coffee Roasters® Hazelnut, 24ct
K-Cup® Pod	Green Mountain Coffee Roasters®	Green Mountain Coffee Roasters® Holiday Blend, 24ct
K-Cup® Pod	Green Mountain Coffee Roasters®	Green Mountain Coffee Roasters® ICED Classic Black, 24ct
K-Cup® Pod	Green Mountain Coffee Roasters®	Green Mountain Coffee Roasters® ICED Hazelnut Cream, 24ct

K-Cup® Pod	Green Mountain Coffee Roasters® ICED Vanilla Caramel, 24ct	Green Mountain Coffee Roasters® ICED Vanilla Caramel, 24ct
K-Cup® Pod	Green Mountain Coffee Roasters®	Green Mountain Coffee Roasters® Kevin Costner Horizon Blend, 24ct
K-Cup® Pod	Green Mountain Coffee Roasters®	Green Mountain Coffee Roasters® Island Coconut, 24ct
K-Cup® Pod	Green Mountain Coffee Roasters®	Green Mountain Coffee Roasters® Lake & Lodge, 24ct
K-Cup® Pod	Green Mountain Coffee Roasters®	Green Mountain Coffee Roasters® Nantucket Blend, 24ct
K-Cup® Pod	Green Mountain Coffee Roasters®	Green Mountain Coffee Roasters® Our Blend, 24ct
K-Cup® Pod	Green Mountain Coffee Roasters®	Green Mountain Coffee Roasters® Southern Pecan, 24ct
K-Cup® Pod	Green Mountain Coffee Roasters®	Green Mountain Coffee Roasters® Sumatra Reserve, 24ct
K-Cup® Pod	Green Mountain Coffee Roasters®	Green Mountain Coffee Roasters® Vermont Country Blend Decaf, 24ct
K-Cup® Pod	Green Mountain Coffee Roasters®	Green Mountain Coffee Roasters® Vermont Country Blend, 24ct
K-Cup® Pod	Green Mountain Coffee Roasters®	Green Mountain Coffee Roasters® Wild Mountain Blueberry, 24ct
K-Cup® Pod	Green Mountain Coffee Roasters®	Keurig® Flavored Coffee Variety Pack, 24ct
K-Cup® Pod	Green Mountain Coffee Roasters®	Keurig® Regular Coffee Variety Pack, 24ct
K-Cup® Pod	illy®	illy® Classico, 20ct
K-Cup® Pod	illy®	illy® Intenso, 20ct
K-Cup® Pod	Intelligentsia	Intelligentsia El Gallo, 20ct
K-Cup® Pod	Intelligentsia	Intelligentsia House Blend, 20ct
K-Cup® Pod	Kahlúa®	Kahlúa® Coffee Original, 24ct
K-Cup® Pod	Krispy Kreme® Doughnuts Coffee	Krispy Kreme® Doughnuts Coffee Classic Decaf, 24ct
K-Cup® Pod	Krispy Kreme® Doughnuts Coffee	Krispy Kreme® Doughnuts Coffee Classic, 24ct
K-Cup® Pod	Krispy Kreme® Doughnuts Coffee	Krispy Kreme® Doughnuts Coffee Original Glazed Doughnut, 24ct
K-Cup® Pod	Laughing Man	Laughing Man Colombia Huila
K-Cup® Pod	Laughing Man	Laughing Man Dukales Blend
K-Cup® Pod	Lipton®	Lipton® Classic Unsweetened Iced Tea
K-Cup® Pod	Lipton®	Lipton® Southern Sweet Iced Tea
K-Cup® Pod	Maxwell House®	Maxwell House® House Blend Decaf, 24ct
K-Cup® Pod	Maxwell House®	Maxwell House® House Blend, 24ct
K-Cup® Pod	Maxwell House®	Maxwell House® Original Roast, 24ct
K-Cup® Pod	McCafé®	McCafé® Baked Apple Pie, 24ct
K-Cup® Pod	McCafé®	McCafé® Blueberry Muffin, 24ct
K-Cup® Pod	McCafé®	McCafé® Breakfast Blend, 24ct
K-Cup® Pod	McCafé®	McCafé® Café Styles of Latin America Café de Olla, 20ct
K-Cup® Pod	McCafé®	McCafé® Café Styles of Latin America Horchata Latte, 20ct
K-Cup® Pod	McCafé®	McCafé® Chocolate Mocha, 24ct
K-Cup® Pod	McCafé®	McCafé® Cinnamon Mocha, 24ct
K-Cup® Pod	McCafé®	McCafé® Cinnamon Streusel Coffee Cake, 24ct
K-Cup® Pod	McCafé®	McCafé® Colombian, 24ct
K-Cup® Pod	McCafé®	McCafé® French Roast, 24ct
K-Cup® Pod	McCafé®	McCafé® Iced One Step Mocha Frappe, 20ct
K-Cup® Pod	McCafé®	McCafé® Irish Mocha, 24ct
K-Cup® Pod	McCafé®	McCafé® Paris Café, 24ct
K-Cup® Pod	McCafé®	McCafé® Premium Roast Decaf, 24ct
K-Cup® Pod	McCafé®	McCafé® Premium Roast, 24ct
K-Cup® Pod	McCafé®	McCafé® Venice Café, 24ct
K-Cup® Pod	Mott's®	Mott's® Hot Apple Cider, 24ct
K-Cup® Pod	Multi-Brand	Keurig® Decaf Coffee Variety Sampler, 24ct
K-Cup® Pod	New England Coffee®	New England Coffee® Blueberry Cobbler, 24ct
K-Cup® Pod	New England Coffee®	New England Coffee® Butter Pecan, 24ct
K-Cup® Pod	New England Coffee®	New England Coffee® Colombian Supremo, 24ct
K-Cup® Pod	New England Coffee®	New England Coffee® Decaf Colombian, 24ct
K-Cup® Pod	New England Coffee®	New England Coffee® Donut Shop Blend Coffee, 24ct

K-Cup® Pod	New England Coffee®	New England Coffee® French Roast, 24ct
K-Cup® Pod	New England Coffee®	New England Coffee® French Vanilla, 24ct
K-Cup® Pod	New England Coffee®	New England Coffee® Hazelnut Creme, 24ct
K-Cup® Pod	New England Coffee®	New England Coffee® New England Breakfast Blend, 24ct
K-Cup® Pod	Newman's Own® Organics	Newman's Own® Organics Newman's Special Blend Decaf, 24ct
K-Cup® Pod	Newman's Own® Organics	Newman's Own® Organics Newman's Special Blend, 24ct
K-Cup® Pod	Peet's Coffee®	Peet's Coffee® Big Bang Coffee, 22ct
K-Cup® Pod	Peet's Coffee®	Peet's Coffee® Brazil Minas Naturais Coffee, 22ct
K-Cup® Pod	Peet's Coffee®	Peet's Coffee® Cafe Domingo, 22ct
K-Cup® Pod	Peet's Coffee®	Peet's Coffee® Decaf House Blend, 22ct
K-Cup® Pod	Peet's Coffee®	Peet's Coffee® French Roast, 22ct
K-Cup® Pod	Peet's Coffee®	Peet's Coffee® Hazelnut Mocha, 22ct
K-Cup® Pod	Peet's Coffee®	Peet's Coffee® House Blend, 22ct
K-Cup® Pod	Peet's Coffee®	Peet's Coffee® Luminosa Breakfast Blend, 22ct
K-Cup® Pod	Peet's Coffee®	Peet's Coffee® Major Dickason's Blend, 22ct
K-Cup® Pod	Peet's Coffee®	Peet's Coffee® Vanilla, 22ct
K-Cup® Pod	REVV®	REVV® Afterburner Coffee, 24ct
K-Cup® Pod	REVV®	REVV® No Surrender Coffee, 24ct
K-Cup® Pod	REVV®	REVV® Turbocharger Coffee, 24ct
K-Cup® Pod	Swiss Miss®	Swiss Miss® Milk Chocolate Hot Cocoa, 22ct
K-Cup® Pod	Swiss Miss®	Swiss Miss® Peppermint Hot Cocoa, 22ct
K-Cup® Pod	Swiss Miss®	Swiss Miss® Reduced Calorie Hot Cocoa, 22ct
K-Cup® Pod	Swiss Miss®	Swiss Miss® Salted Caramel Hot Cocoa, 22ct
K-Cup® Pod	The Original Donut Shop®	The Original Donut Shop® Caramel Latte, 20ct
K-Cup® Pod	The Original Donut Shop®	The Original Donut Shop® Chocolate Glazed Donut, 24ct
K-Cup® Pod	The Original Donut Shop®	The Original Donut Shop® Cinnamon Dulce Cappuccino, 20ct
K-Cup® Pod	The Original Donut Shop®	The Original Donut Shop® Cinnamon Toast Crunch Latte, 20ct
K-Cup® Pod	The Original Donut Shop®	The Original Donut Shop® Classic Cappuccino, 20ct
K-Cup® Pod	The Original Donut Shop®	The Original Donut Shop® Cookie Dough So Delicious, 24ct
K-Cup® Pod	The Original Donut Shop®	The Original Donut Shop® Dark, 24ct
K-Cup® Pod	The Original Donut Shop®	The Original Donut Shop® Decaf, 24ct
K-Cup® Pod	The Original Donut Shop®	The Original Donut Shop® Duos Coconut + Mocha, 24ct
K-Cup® Pod	The Original Donut Shop®	The Original Donut Shop® Duos Nutty + Caramel, 24ct
K-Cup® Pod	The Original Donut Shop®	The Original Donut Shop® Duos White Chocolate + Vanilla, 24ct
K-Cup® Pod	The Original Donut Shop®	The Original Donut Shop® Iced Duos Cookie + Caramel, 24ct
K-Cup® Pod	The Original Donut Shop®	The Original Donut Shop® Mocha Latte, 20ct
K-Cup® Pod	The Original Donut Shop®	The Original Donut Shop® Peppermint Bark, 24ct
K-Cup® Pod	The Original Donut Shop®	The Original Donut Shop® Red Velvet Latte, 20ct
K-Cup® Pod	The Original Donut Shop®	The Original Donut Shop® Regular, 24ct
K-Cup® Pod	The Original Donut Shop®	The Original Donut Shop® Snickers, 24ct
K-Cup® Pod	The Original Donut Shop®	The Original Donut Shop® Vanilla Cream Puff, 24ct
K-Cup® Pod	The Original Donut Shop®	The Original Donut Shop® Vanilla Latte, 20ct
K-Cup® Pod	The Original Donut Shop®	The Original Donut Shop® Coffee Twix™, 24ct
K-Cup® Pod	Tim Hortons®	Tim Hortons® Dark Roast Coffee, 24ct
K-Cup® Pod	Tim Hortons®	Tim Hortons® Decaf Coffee, 24ct
K-Cup® Pod	Tim Hortons®	Tim Hortons® Original Blend Coffee, 24ct
K-Cup® Pod	Tully's®	Tully's® Coffee Breakfast Blend, 24ct
K-Cup® Pod	Tully's®	Tully's® Coffee French Roast Decaf, 24ct
K-Cup® Pod	Tully's®	Tully's® Coffee French Roast, 24ct
K-Cup® Pod	Tully's®	Tully's® Coffee Hawaiian Blend, 24ct
K-Cup® Pod	Tully's®	Tully's® Coffee Italian Roast, 24ct

FEATURES

Function lights

Blue Light "Heating" is on steady on the Brew Selection panel indicates water is heating.

Blue Light "Load Coffee Pod" is on steady on Brew Selection panel indicates water heating is at temperature and ready for brewing.

Blue Light "Select Cup Size" is on steady on Brew Selection panel indicates the cup size (6 oz, 8 oz, 10 oz) could be chosen to brew coffee.



Blinking **Blue light** above faucet area and Blinking **Blue light " Replace Bottle"** on the Brew Selection panel indicate that the bottle is nearly empty.

Blinking **Blue light** above the faucet area indicates that the SmartFlo™ Water Cartridge has reached its (suggested) usage limit and should be changed.

Cold Water Lever – Depress lever to dispense water. Release lever to stop.

Hot Water Lever (with child safety feature) – Push **Red** button into the cooler and depress lever to dispense water. Release lever to stop.

Coffee and Water Outlet – Coffee, Hot and Cold water is dispensed from this location.

LED Nightlight – Located behind faucet levers. Provides additional light in low light situations (activated when water lever is depressed).

Raised Drip Tray– Top rack dishwasher safe. Push up and down. Position glass or cup over center to avoid spills.

Drip Tray Base and Cover – Top rack dishwasher safe. Snaps in and out. Position glass or cup over center to avoid spills.

Hot Tank Power Switch – Located in the bottle installation area at top. Turn the Hot Tank Power Switch Off to stop the hot water heating function.

Bottle Adaptor Assembly – Located inside of cabinet. Connects to bottle to allow water to be pumped into the hot and cold reservoirs.

Water Bottle – Not included. Uses standard 3, 4, or 5 gallon water bottles.

SmartFlo™ Water Cartridge - Design allows for quick and easy sanitization of the cold water system (Figures 1 & 2).



Figure 1



Figure 2

GETTING STARTED

Locate water dispenser

1. Place the water cooler on a flat level surface in a cool shaded location near a grounded wall outlet.
2. Position water dispenser so that the back of the unit is a minimum of 4 inches / 10 cm away from the wall to ensure proper ventilation (Figure 3).

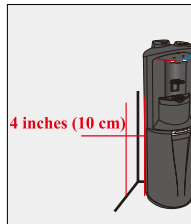

Figure 3

Install water bottle

1. Slide the door upward to access bottle area (Figure 4).
2. Place fresh bottle outside of the cabinet.
3. Clean the outside of new bottle with a clean cloth (Figure 5).
4. Remove bottle cap completely from the top of the bottle (Figure 6).
5. Un-package and assemble the bottle adaptor assembly (located in the bottle storage area).
6. Place the bottle adaptor probe into the bottle (Figure 7).

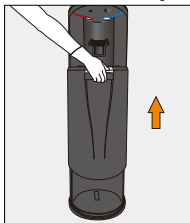

Figure 4



Figure 5

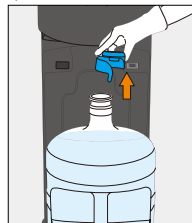

Figure 6



Figure 7

7. Slide the bottle adaptor over the neck of the bottle and push down to secure (Figure 8).
8. Push probe down until the tube hits the bottom of bottle (Figure 9).
9. Remove the red plug from the SmartFlo™ water line and install onto the bottle adaptor assembly (Figure 10). Save the red plug for future use.
10. Slide bottle into cabinet and close the door by sliding downward (Figure 11).

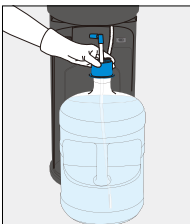

Figure 8

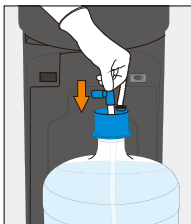

Figure 9

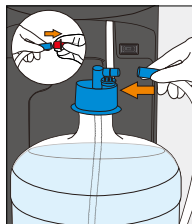

Figure 10

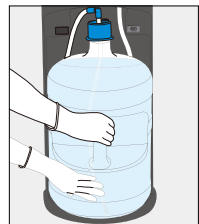

Figure 11

Provide electricity

Ensure that the available power supply matches the cooler's voltage specifications indicated on the nameplate label (located at the rear of unit).

Connect to power supply.

Please ensure that cooler is set up so as access to the power outlet and plug is unobstructed.

Note: DO NOT turn on the Hot Tank Power Switch yet. Proceed to the "Prime Water System" section.

Note: To provide additional protection from the risk of shock, this unit MUST be connected to a ground fault circuit interrupter (GFCI) outlet at all times. Use of an extension cord will void any warranties.

Prime water system (required during initial setup and after replacement of SmartFlo™ Water Cartridge)

Depress the **Cold** water lever first, and then **Hot** water lever (separately, not at same time) to fill their respective tanks. When water begins to flow from the faucet, the tank has been filled (approx. 1 minute per tank).

Activate Heating Functions

Ensure priming of water system is complete before starting this step.

Notice: Hot water will not be dispensed by the cooler until the **Hot Tank Power Switch** has been activated, located behind and at top of bottle access door.

Turn on the **Hot Tank Power Switch** (Red color).

- To disable the heating function (Hot Water), turn off the **Hot Tank Power Switch** (Figure 12).

DO NOT draw water from the cooler for about 30 minutes to let the water cool or heat.

Optimum water temperatures will be reached after several hours of operation.

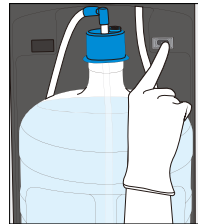

Figure 12

Dispensing water

The SmartFlo™ Water Cartridge has been tested and sanitized prior to packaging. During transit dust and odors may accumulate in the water tanks and lines. Dispense and dispose of at least 1 quart (1 liter) of water prior to drinking any water.

Cold water dispensing

The temperature control of the cold water is preset to dispense water between 39.2-50°F (4 to 10°C).

Optimum cold water temperatures will be reached after several hours of operation. During this time the compressor could run continuously. This is normal (Figure 13).

1. Position bottle, glass or other container below water outlet.
2. Push cold water lever downward to start water flow.
3. Release cold water lever once desired fill level is achieved.



Figure 13

Coffee dispensing

The temperature control of the coffee is preset to dispense water between 190.4-201.2°F (88 to 94°C).

1. Place cup on drip tray.
2. Open coffee pod holder lid, put coffee pod into holder and close the lid.
3. **Blue** Select Cup Size is on steady, make 6 oz, 8 oz or 10 oz selection, then press Brew button to dispense coffee.

Note: If Cup Size (6 oz, 8 oz, 10 oz) is not be selected within 60 seconds or Brew button is not pressed within 30 seconds of selection, the selection lights will go out and selection process must be repeated after opening and closing pod holder lid.

Hot water dispensing

The temperature control of the hot water is preset to dispense water between 188.6-199.4°F (87 to 93°C).

Optimum hot water temperatures will be reached after 15-20 minutes.

1. Position bottle, glass or other container below water outlet (Figure 14).
2. Push the **Red safety button** in, and push down the hot water lever to start hot water flow (Figure 15).
3. Release hot water lever once desired fill level is achieved.



Figure 14

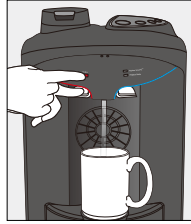

Figure 15

Bottle change

A flashing **Blue** light above the cold water lever and “Replace Bottle” light is on steady on the Brew Selection panel will alert you when your water bottle is getting low. The bottle will need to be replaced shortly. Water may be dispensed normally until empty (no water flows from water outlet when levers are depressed).

1. Open dispenser door (Figure 16) and slide upward to allow access to bottle area.
2. Slide empty bottle out of cabinet (Figure 17).
3. Place fresh bottle outside of the cabinet.
4. Clean the outside of new bottle with a clean cloth (Figure 18).
5. Remove bottle cap completely from the top of the bottle (Figure 19).

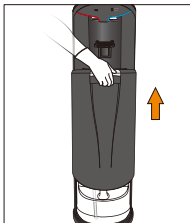

Figure 16

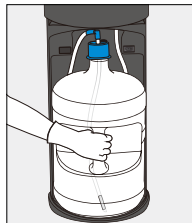

Figure 17



Figure 18

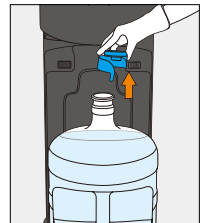

Figure 19

6. Remove bottle adaptor from the empty bottle (Figure 20) and place directly into the top of the new, full bottle (Figure 21).

Note: to maintain integrity of the system, refrain from touching the section of the bottle adaptor tube that is inserted into the bottle.

7. Slide the bottle adaptor over the neck of the bottle and push down to secure (Figure 22).

8. Push probe down until the tube hits the bottom of bottle (Figure 23).

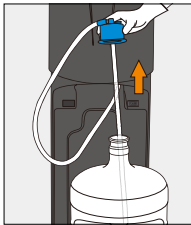

Figure 20

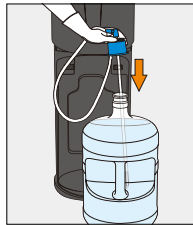

Figure 21

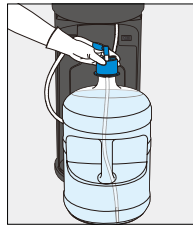

Figure 22

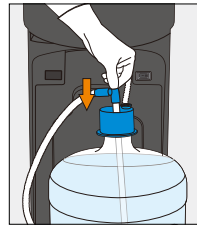

Figure 23

9. Slide bottle into cabinet and close the door by sliding downward (Figure 24 to Figure 26).

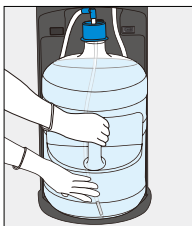

Figure 24

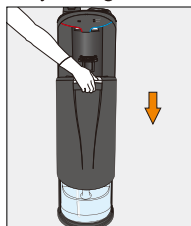

Figure 25

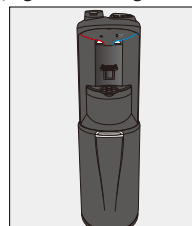

Figure 26

10. Place a container under faucet and dispense cold water until a smooth stream of water is dispensed (may take up to 1 minute).

CLEANING AND SANITIZATION

Notice

The information and/or procedures presented in the following demonstration(s) should be performed by a trained water cooler service technician only (except daily cleaning of coffee pod holder and monthly cleaning with detergent pod).

Never attempt to service or repair a water cooler while it is plugged into any power supply.

Prior to any service or repair of the water cooler, ensure that the water has been completely drained from the system.

Scheduled cleaning and sanitizing are recommended to ensure the integrity of the drinking water. The frequency of cleaning will vary depending on the conditions and environment.

Follow the steps outlined in this document for cleaning and sanitizing the water cooler.

CAUTION: DO NOT IMMERSE THE UNIT IN WATER OR CLEAN USING PRESSURE WASHER.

The daily cleaning of coffee pod holder and monthly cleaning with detergent pod maybe performed by the end user.

Cleaning tips to help maintain the Storm Café in clean and hygienic state

- Wash hands thoroughly with soap and water for at least 20 seconds and/or use an alcohol-based hand sanitizer containing a minimum 60% alcohol prior to cleaning and sanitizing.
- All surfaces should be cleaned prior to disinfection using a mild dish detergent and water.
- Spray a clean cloth with an EPA registered / approved disinfectant. Wipe down all brewer screens, touch buttons, the coffee pod holder and external surfaces to disinfect. Take care to read the label and ensure that it will meet your needs.

Daily cleaning of coffee pod holder

1. Using the top cover key (Figure 27), insert into the two holes (on the front, approximately 2 inches above and to the right of hot water safety button). Push key inward to open top cover (Figures 28 & 29).

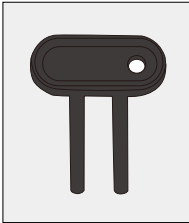

Figure 27

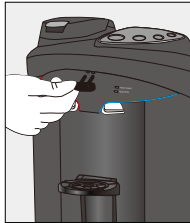

Figure 28

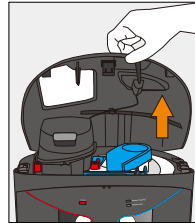

Figure 29

2. Open the coffee pod holder lid (Figure 30). Remove the coffee cup holder (brown) (Figure 31) and discard or machine wash (top rack only). Turn the red twist locks on each side to release and take out the bottom part of coffee pod holder (Figures 32, 33, 34).

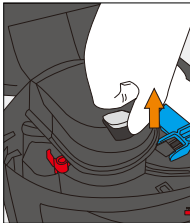

Figure 30

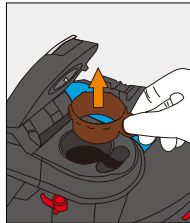

Figure 31

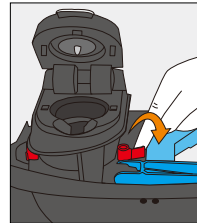

Figure 32

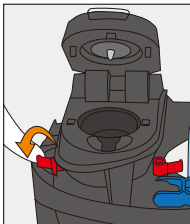

Figure 33

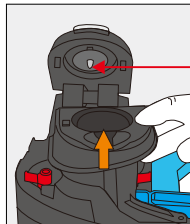

Figure 34

CAUTION!
During the cleaning and/or sanitizing process, the Top Needle Gasket may be removed. The Top Needle Gasket must be re-installed prior to use to prevent personal injury or equipment damage.

3. Open the catch on each side, lift out the top coffee pod holder component (Figures 35, 36, 37). Wash both components of the coffee pod holder with a food grade dish detergent for at least 1 minute. Dry using a clean cloth or air dry (Figure 38).

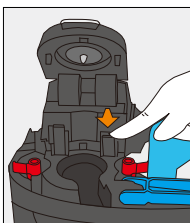

Figure 35

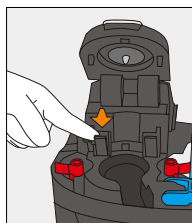

Figure 36

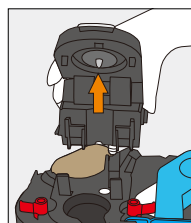

Figure 37

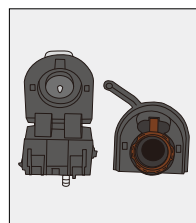

Figure 38

4. Install the cleaned top coffee pod holder components in the cooler (Figure 39), closing the catch on each side (Figure 40). Slide the bottom part of coffee pod holder into place (Figure 41), turning both red twist locks to secure (Figure 42). Place a clean cup holder (brown) in the pod holder (Figure 43) and push down to close the lid (Figure 44).

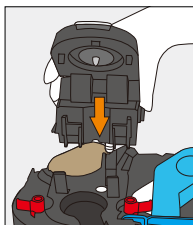

Figure 39

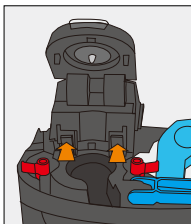

Figure 40

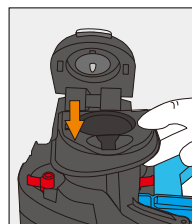

Figure 41

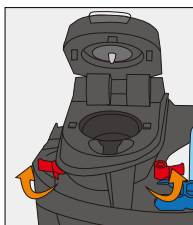

Figure 42

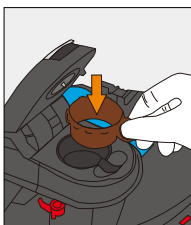

Figure 43

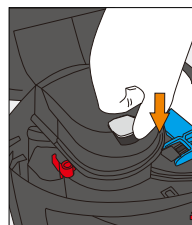

Figure 44

Food grade detergents for cooler cleaning and sanitization

- Food grade dish detergent
- Other food grade cleaner
- EPA registered disinfectant

Monthly cleaning with detergent pod (not supplied)

1. With the coffee machine turned on and at temperature, open the coffee pod holder (Figure 45), insert the detergent pod and close lid (Figure 46).

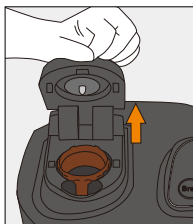

Figure 45

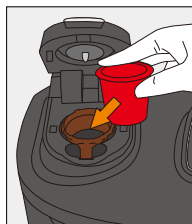

Figure 46

2. Place a 10 oz or larger glass or similar container under the water outlet (Figure 47). Select the 10 oz option and press the “Brew” button to start the cleaning cycle (Figure 48).

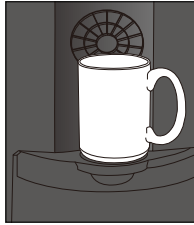

Figure 47

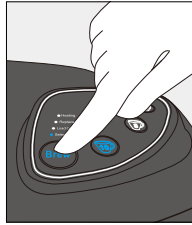

Figure 48

3. Upon completion of the cleaning cycle, clean the coffee pod holder using the “Daily Cleaning” procedures in this document.
4. Once the cleaned coffee pod holder is installed, press the 6, 8, or 10 oz option and press the “Brew” button to flush hot water through the unit without inserting a coffee pod into the pod holder. Repeat five times or until no detergent residue is detected.

Note: The detergent pod is a special cleaning agent used specifically for cleaning coffee pod-type machines. A food grade detergent must be used.

Basic cleaning

1. Use sterile nitrile gloves or wash hands with soap and water for 20 seconds before and after handling water contact parts.
2. Remove raised drip tray assembly and disassemble it for cleaning (Figure 49).
3. Using clean cloth, wipe raised drip tray support, and wash the drip tray grill and base using mild dish detergent (Figures 50, 51, 52).

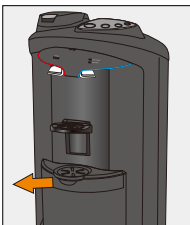

Figure 49

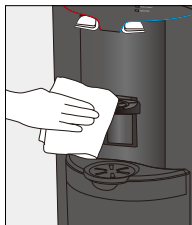

Figure 50

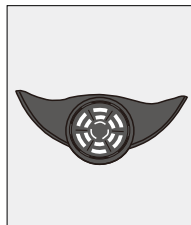

Figure 51

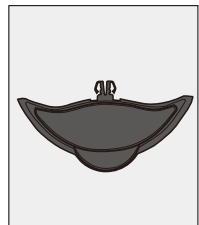

Figure 52

4. Lift door up (Figure 53), turn off the hot tank power switch (Figure 54) and unplug the water cooler (Figure 55).

CAUTION: WATER IN HOT TANK IS VERY HOT AND CAN CAUSE SEVERE BURNS. ALLOW SUFFICIENT TIME FOR THE HOT WATER TO COOL BEFORE DRAINING (1-2 HOURS).

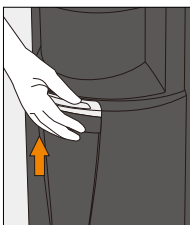

Figure 53

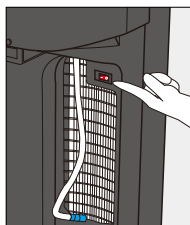

Figure 54

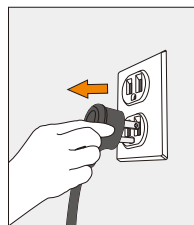

Figure 55

5. Take bottle out from the base (Caution: don't break the corrugated tube). Remove the connector from adaptor (Figure 56). A plug should be added to the end of the tube, to stop the water dripping on the floor (Figure 57). Save the red plug for future use.

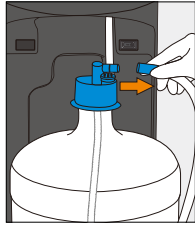

Figure 56

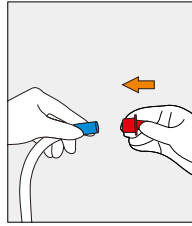

Figure 57

6. Using the top cover key (Figure 58), insert into the two holes (on the front, approximately 2 inches above and to the right of hot water safety button). Push key inward to open top cover (Figures 59 & 60).

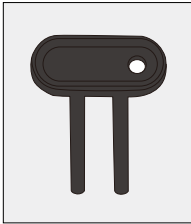

Figure 58

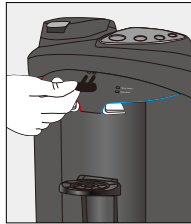

Figure 59

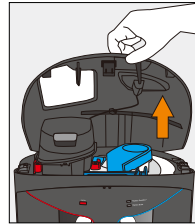

Figure 60

7. Squeeze the latch's end to open (Figures 61 & 62). Rotate the blue knobs to release the SmartFlo™ (Figure 63 & 64). Pull to remove the SmartFlo™ Water Cartridge and discard in recycling bin (Figures 65 & 66).

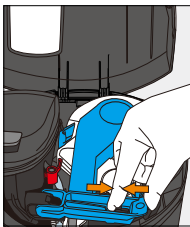

Figure 61

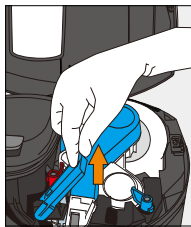

Figure 62



Figure 63

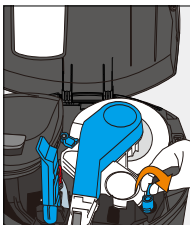

Figure 64



Figure 65

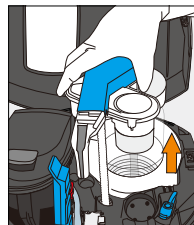

Figure 66

8. To drain the hot tank, use a #2 Phillips screwdriver, remove the drain cap cover on the rear of the cooler. Using a flat blade screw driver or 1/2" socket, remove the drain cap and plug (Figure 67 & 68). Drain water into a pail or container (at least 0.5 gal.) (Figure 69) and discard. Replace drain plug and cap, attach drain cover (Screw installation torque 4.5 kgf.cm).

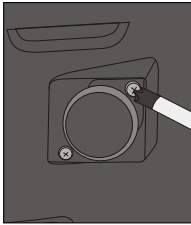

Figure 67

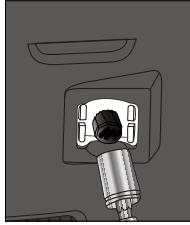

Figure 68

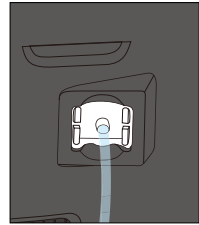

Figure 69

9. It is recommended that the hot tank be descaled periodically (depending upon water quality and usage). Only the use of food-safe descaling agents, compatible with 304 grade stainless steel is recommended. The use of the descaling agents must be in accordance with the manufacturer's safety instructions and recommendations and performed by properly trained personnel. Note: Ensure that the hot tank is empty and that the drain, plug, cap and cover are securely in place (screw installation torque 4.5 kgf.cm) (Figure 70). Using a funnel, add the descaling solution to the hot tank, filling up to the top of the inlet (approx. 38.7oz/1100ml) (refer to Figure 71). In accordance with the manufacturer's instructions for the solution, allow the solution time to descale, and then drain and dispose of the solution.

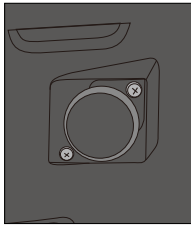

Figure 70

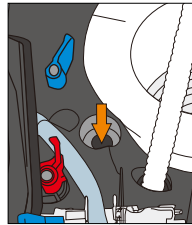

Figure 71

10. Wipe evaporator with a clean cloth (Figure 72).

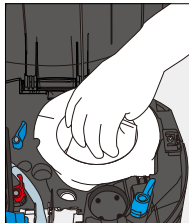

Figure 72

11. Use a stiff, non-metallic brush or vacuum attachment to clean the condenser and all accessible areas to remove dirt, lint and debris. Use a clean damp cloth to wipe down condenser (Figure 73).

CAUTION: DO NOT CLEAN USING PRESSURE WASHER OR ANY DIRECT WATER CONTACT.

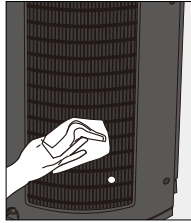

Figure 73

12. Lift door up to open. Brush, vacuum and wipe to clean the interior of condenser (Figures 74 & 75).

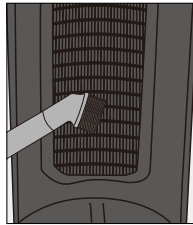

Figure 74

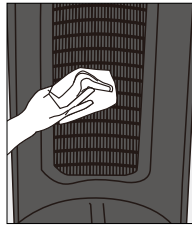

Figure 75

13. Install a new SmartFlo™ Water Cartridge. Install the connector and corrugated tube into the inlet through cooler to bottom (Figures 76 & 77). Insert the reservoir into evaporator (Figure 78). Ensure the SmartFlo™ is installed properly. Turn the two blue knobs to lock the SmartFlo™ in place (Figures 79 & 80).

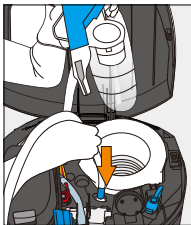

Figure 76

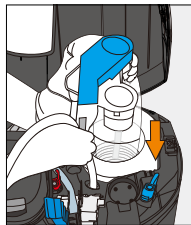

Figure 77

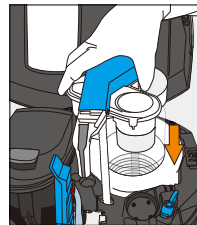

Figure 78



Figure 79

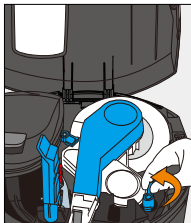

Figure 80

14. Close and lock the latch arm (Figure 81).

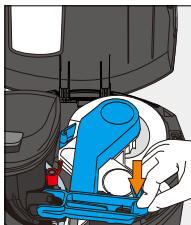

Figure 81

15. Remove the red plug from the blue tube of the SmartFlo™ Water Cartridge and install onto the bottle adaptor assembly (Figure 82). Save the red plug for future use.

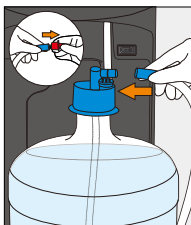

Figure 82

16. Close the top cover and lower the door to close. Plug the cooler into the electrical outlet. Prime water system (required during initial setup and after replacement of SmartFlo™ Water Cartridge). Depress the **Cold** water lever first, and then **Hot** water lever (separately, not at same time) to fill their respective tanks. When water begins to flow from the faucet, the tank has been filled (approx. 1 minute per tank) (Figures 83 & 84).



Figure 83

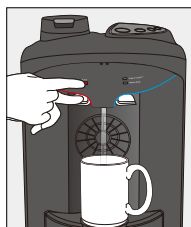

Figure 84

17. Lift the door to open. Turn the hot tank power switch ON. Push downward to close the door.

CAUTION: TO PREVENT DAMAGE TO THE HOT TANK, DO NOT SWITCH ON IF HOT TANK IS EMPTY.

Replacement of SmartFlo™ Water Cartridge

For the best tasting and highest quality water, it is recommended to change the SmartFlo™ Water Cartridge every 12 months. Follow the instructions that are provided with your replacement SmartFlo™ Water Cartridge. It is recommended to empty the bottle prior to replacement of the SmartFlo™ Water Cartridge and bottle adaptor. A flashing blue light above the cold water lever will alert you to when the SmartFlo™ Water Cartridge should be replaced. The system has been pre-set to provide indication of this after a period of 12 months of use. User may operate the cooler as normal until the bottle has been completely emptied.

Note: To reset the life timer system, the SmartFlo™ is required to be removed from the dispenser for a minimum of 15 seconds, while the unit is connected to the mains power supply (if your SF light does not reset after following these steps, your model may require that the unit be power cycled for 10 seconds to complete the reset process).

TROUBLESHOOTING

Water leaks

- If water present only at base of unit (not dripping from above), first try to replace the water bottle.
- If water leaking from above the bottle (or not bottle related), unplug dispenser, remove bottle and contact your local supplier or Crystal Mountain for assistance.

Water not dispensing

- Ensure hot/cold tanks have been primed (see section for priming of water system).
- Ensure bottle is not empty. If empty, replace it.
- Ensure that the water selection lever is fully depressed.
- Ensure all SmartFlo™ tubing is free of any holes, cuts or cracks.
- Ensure SmartFlo™ locking knobs (in top) are securely locked in place.

Not cooling (hot water functioning)

- Optimum cold water temperatures will be reached after several hours of operation.
- Ensure that the dispenser is at least 4 inches (100mm) from the wall to provide sufficient ventilation.
- If the water still isn't cold, please contact your local supplier or Crystal Mountain for assistance.

No hot water (cold water functioning)

- Optimum hot water temperatures will be reached after 15-20 minutes.
- Ensure that the Hot Tank Power Switch (located behind top right side of bottle access door) is turned on.
- If the water still isn't hot, please contact your local supplier or Crystal Mountain for assistance.

No coffee out (hot water and cold water are functioning)

- Ensure the needle is not Blocked.
- Ensure the coffee pod holder lid completely closed.
- If the water still isn't hot, please call contact your local supplier or Crystal Mountain for assistance.

Dispenser is noisy

- Ensure that the dispenser is positioned on a flat, level surface.
- Ensure that the bottle is not empty. If empty, replace it.

Brewer only makes a Partial Cup or Brew Volumes Vary

- The exit needle may be clogged. See instructions in service manual for instructions for Cleaning the Inlet / Outlet Needle.
- Slight variations in brew volume may occur due to variations in dispense temperature, pod type and location altitude. These differences in volumes may be very slight between the different brew sizes.

SAFETY PRECAUTIONS

WARNING

To reduce risk of injury and property damage, the user must read this entire guide before assembling, installation and operation of the dispenser.

Failure to follow the instructions in this manual can cause personal injury or property damage.

This product dispenses water at very high temperatures. Failure to use properly can cause personal injury.

When operating this dispenser, always exercise basic safety precautions, including the following:

- Prior to use, this dispenser must be assembled and installed in accordance with this manual.
- Install indoors on a flat level surface only. Place dispenser in a dry place away from direct sunlight. Do NOT use outdoors.
- This appliance is intended to be used in household and similar applications such as:
 - Staff kitchen areas in shops, offices and other working environments.
 - Farmhouses and by clients in hotels, motels and other residential type environments.
 - Bed and breakfast type environments.
 - Catering and similar non-retail applications.
- Do NOT place dispenser into an enclosed space or cabinet.
- This dispenser is intended for dispensing water only. Do NOT use other liquids. Never use any other liquid in the dispenser other than known and microbiologically safe bottled water. Only water and coffee pods are acceptable.
- Do not use an extension cord. Use of an extension cord will void any warranties.
- To provide additional protection from the risk of shock, this unit MUST be connected to a ground fault circuit interrupter (GFCI) outlet at all times.
- If the supply cord is damaged, it must be replaced by a special cord or assembly available from the manufacturer or its service agent.
- Always grasp plug and pull straight out from outlet. Never unplug by pulling on power cord.
- To protect against electric shock, do NOT immerse cord, plug, or any other part of dispenser in water or other liquids.
- This appliance is not intended for use by persons (including children) with reduced physical, sensory or mental capabilities, or lack of experience and knowledge, unless they have been given supervision or instruction concerning use of the appliance by a person responsible for their safety.
- Children should be supervised to ensure that they do not play with the appliance.
- Use with caution only.
- Service should only be performed by a certified technician. Please contact your supplier or Crystal Mountain if assistance is needed.

Services required:

See nameplate located on the back of the dispenser

Refrigeration system

- Refrigerant Type: R134a, 1.13oz (32g)
- Pressure (Refrigeration): High Side: 265 PSI, Low Side: 140PSI

Water flow

- The flow rate from the water outlets on the dispenser is a maximum of 0.475 US gal/minute (1800 ml/minute)

The customer acknowledges that water, like other liquids, can cause damage to surfaces. The customer takes full responsibility for placing the cooler within a residence or business, and acknowledges that failure to address drips, leaks or spillages is at the customer's risk.

The Warranty and Underwriters' Laboratory for the coolers are invalidated if any alteration, modification, or use or misuse in combination with any other machine or devices is deemed to be the source of any claim. The manufacturer accepts no liability (including for bodily injury) resulting from any alteration, misuse, neglect, accidents, improper installations or repairs.

Environmental application temperature: 50~90°F (10~32°C).

The unit is rated IP10 (i.e. this unit is not protected against ingress of water).

For more information on this product, please visit www.crystalcoolers.com

