



41180 Raintree Court
Murrieta, CA 92562
1-888-304-0660
www.waterstoneco.com

ITEM NO: **4055**

STYLE: **TRADITIONAL**

INTENDED USE:
SOAP/LOTION DISPENSER

CUSTOMER NAME:

JOB NO:

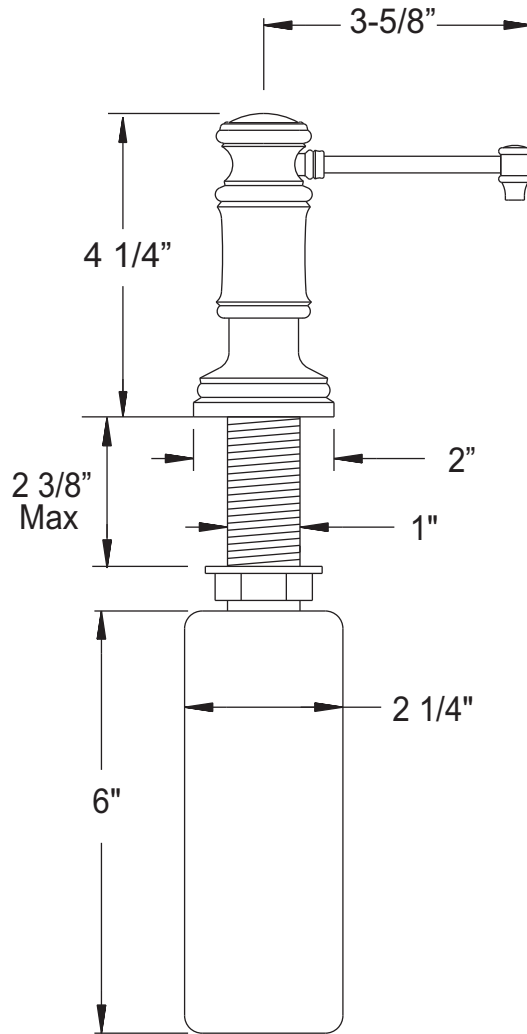

DIMENSIONS MAY VARY AND ARE SUBJECT TO CHANGE. NO RESPONSIBILITY IS ASSUMED FOR USE OF SUPERCEDED OR VOIDED DATA

Technical Specifications

- Solid brass construction.
- "Anti-wick" tip helps protect delicate patina finishes.
- 3 accent buttons included: 1 Soap, 1 Lotion, 1 plain with matching finish.
- PTFE guides for smooth action and solid feel.
- Easily replaceable pump.
- 12oz capacity (approx).
- Refill from top design.
- Requires 1-3/8" mounting hole.

DATE: 10-26-07



MADE IN THE USA