



T&S BRASS AND BRONZE WORKS, INC.

2 Saddleback Cove / P.O. Box 1088
Travelers Rest, SC 29690



REG. #A2601
ISO #9001

Model No.
B-7132-02

Item No.

Travelers Rest, SC: 800-476-4103 Simi Valley, CA: 800-423-0150 Fax: 864-834-3518 www.tsbrass.com

This Space for Architect/Engineer Approval

Job Name _____ Date _____

Model Specified _____ Quantity _____

Customer/Wholesaler _____

Contractor _____

Architect/Engineer _____

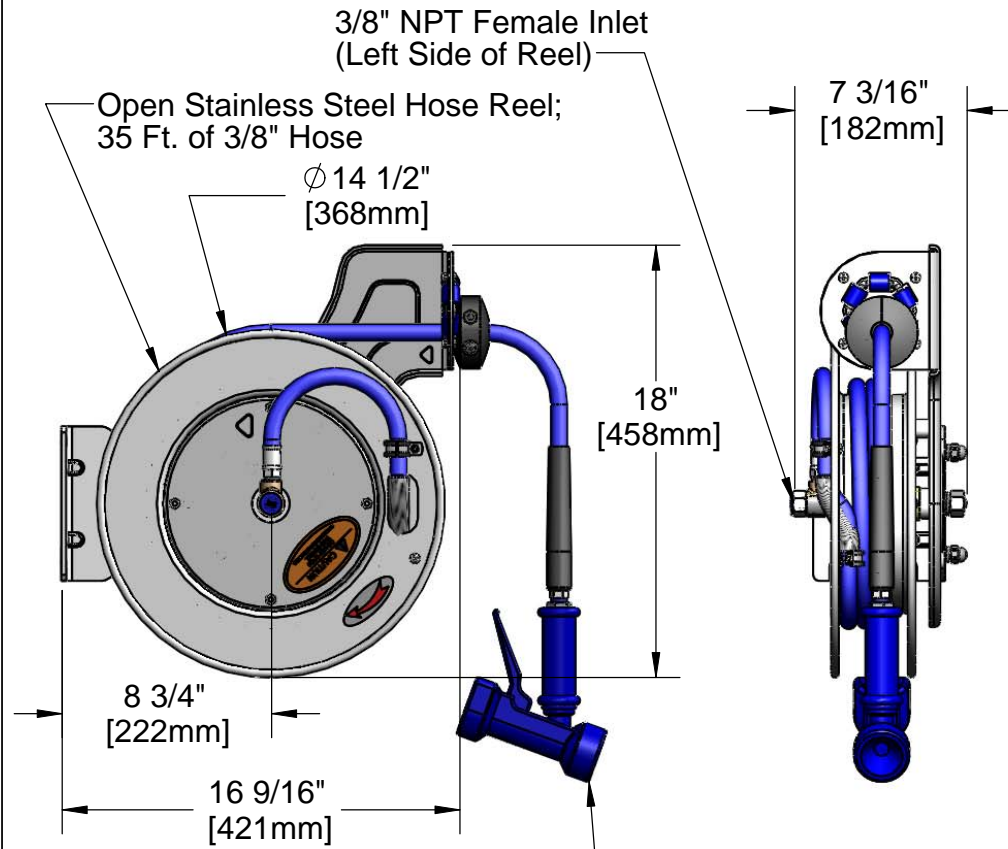
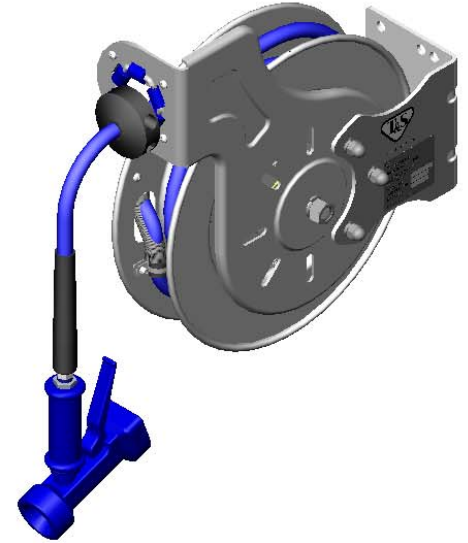

MV-2516-24 Rear Trigger Style Gun
w/ Retractable Hold Down Clip,
Stainless Steel Body and Royal
Blue Rubber Cover.

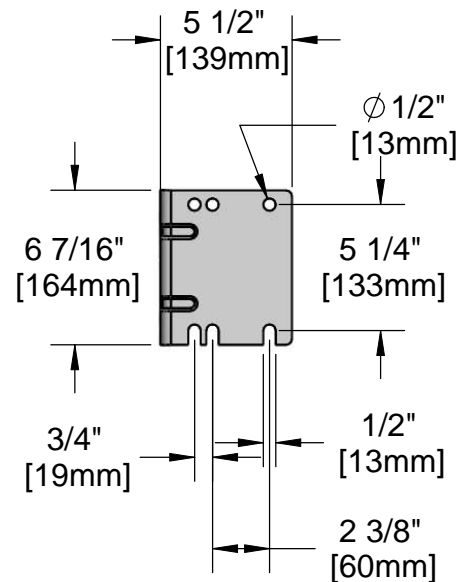

Product Specifications:

3/8" x 35 Ft. Open Stainless Steel Reel
MV-2516-24 Rear Trigger, 5/16" Spray Gun

Drawn JRM	Checked DHL	Approved JHB
Scale: 1:8		Date: 1/05/10



T&S BRASS AND BRONZE WORKS, INC.

2 Saddleback Cove / P.O. Box 1088
Travelers Rest, SC 29690



REG. #A2601
ISO #9001

Model No.
B-7132-02

Item No.

Travelers Rest, SC: 800-476-4103 Simi Valley, CA: 800-423-0150 Fax: 864-834-3518 www.tsbrass.com

ITEM NO.	SALES NO.	DESCRIPTION
1	MV-2516-24	5/16" Orifice, Rear Trigger Gun
2	014938-45	Roller Assembly Repair Kit
3	014949-45	Hose Stop Repair Kit
4	014941-45	3/8" x 35' Hose Replacement Kit
5	014933-45	Small SS Spring Assembly Kit
6	014946-45	3/8" Swivel Repair Kit
7	014948-45	O-Ring Replacement Kit
8	014940-45	Ratchet Repair Kit
9	001359-40	1/2" NPT-M x 3/8" NPT-F Adapter

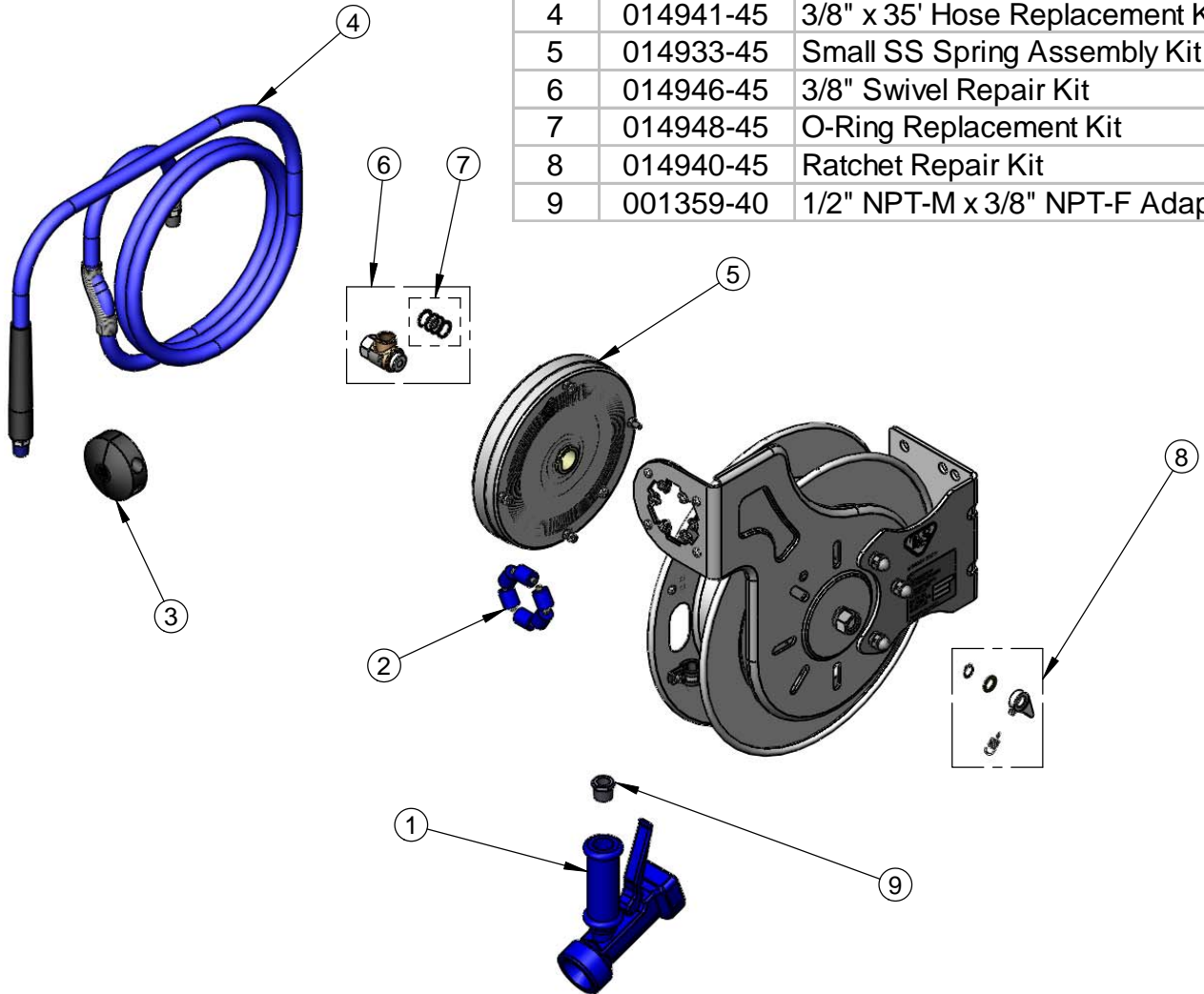

Product Specifications:

3/8" x 35 Ft. Open Stainless Steel Reel
MV-2516-24 Rear Trigger, 5/16" Spray Gun

Drawn JRM	Checked DHL	Approved JHB
Scale: 1:8		Date: 1/05/10