

**[Install Method]**

It is easy to install and this is a big benefit of this product. Without piercing 4 square panel wall to install, it is a big benefit that you can install only to pierce 20 pie circle hole.

1. Make a hole for 20 pie circle on the panel wall.
2. Apply both-sided tape to the both side of LSM product back in order to immobilize the product.
3. While the coaxial cable is not connecting to the back of the product, unscrew the nut and insert the back to the circle hole horizontally and then screw the nut and close clockwise.
4. For the last step, please connect the sensor cable to the coaxial cable.

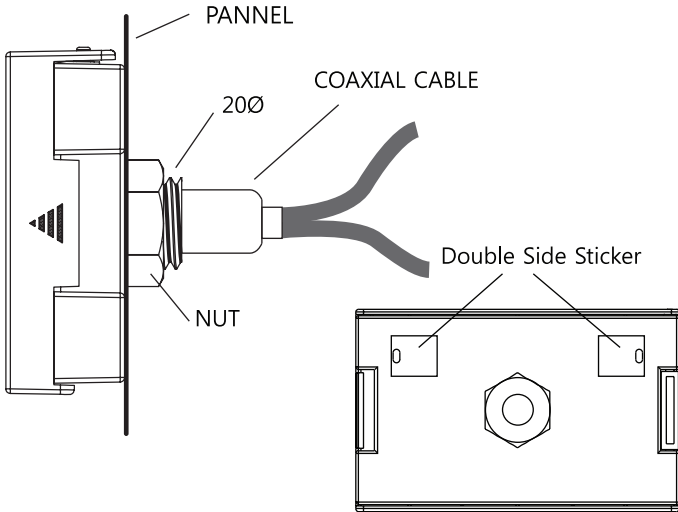

- 5 -

**[Method of Measurement]**

1. Connect the sensor.
2. To open, please pull the handle on the right corner of the screen.
3. To turn on the power, please press the on/off button on the switch inside the screen.
4. Select the next unit measure using OUT/SET button.  
The units are (mS ---> ppt ---> uS ---> ppm).
5. On the screen LINE 1 and LINE 2, the current measurement is appeared and the Rejection measurement is also appeared on the top of the screen.
6. If the Rejection measurement is already set up, during the operating, the "CHANGE" icon is blinking if is below that % cell point.

**[Rejection Function]**

Rejection is a function that shows how well the purifying filter works indicating the rate hourly.

For example, if it shows that IN-LINE

- 1 is 100uS and OUT-LINE
- 2 is 20us, then it means 80% has been purified. The lower Rejection measurement means that the power of purifying is low. Therefore, if after you set the Rejection measurement then the measurement become lower, you will see the "CHANGE" icon is blinking then it is time to replace the filter.

$$\text{Rejection(\%)} = (\text{LINE1} - \text{LINE2}) / \text{LINE1} \times 100$$

EX) LINE1=50uS, LINE2=10uS ; Rejection = 80%

- 2 -

HM DIGITAL

**ONE YEAR LIMITED WARRANTY**

The Rejection Monitor ("LDM-100R"), manufactured by HM Digital, Inc. ("the Company") is warranted to the purchaser against defective materials and workmanship for one (1) year from the date of purchase.

**What is covered:** Repair parts and labor, or replacement at the Company's option. Transportation charges for repaired or new product to be returned to the purchaser.

**What is not covered:** Transportation charges for the defective product to be sent to the Company. Any consequential damages, incidental damages, or incidental expenses, including damages to property. This includes damages from abuse or improper maintenance such as tampering, wear and tear, water damage, or any other physical damage. The warranty does not cover water damage to the LDM-100R due to parts not securely closed. Products with any evidence of such damage will not be repaired or replaced.

**How to obtain warranty performance:** Attach to the product your name, address, description of problem, phone number, and proof of date of purchase, package and return to:

HM Digital, Inc.  
ATTN: Returns  
5819 Uplander Way  
Culver City, CA 90230  
U.S.A.

**Implied Warranties:** Any implied warranties, including implied warranties of merchantability and fitness for a particular purpose, are limited in duration to five years from date of purchase. Some states do not allow limitations on how long an implied warranty lasts, so the above limitation may not apply to you. To the extent any provision of this warranty is prohibited by federal and state law and cannot be preempted, it shall not be applicable. This warranty gives you specific legal rights, and you may also have other rights, which vary from state to state.

**NOTE:** Warranties are product-specific. Third-party products and products deemed by HM Digital as "accessories" are not covered under warranty. Third-party products include, but are not limited to, batteries and fittings. Accessories include, but are not limited to batteries, lanyards and cases.

www.hmdigital.com

**REJECTION MONITOR  
USER'S GUIDE**

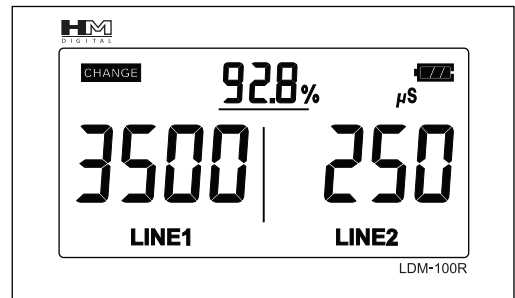

**LDM-100R**



**PROFESSIONAL WATER  
TESTING INSTRUMENTS**

**[Rejection Setting]**

1. Press and hold "SET" button for 5 seconds.
2. The Rejection measurement is blinking and setting up the measurement.
3. You can set up the number pressing UP/DOWN button.
4. Then press ENTER to save.

**[Method of Calibration]**

Please prepare the standard solution for calibration

1. Press On/Off button to turn on the power.
2. Dip the sensor of LINE- into 700uS standard solution and wait about 30 – 60 seconds.
3. You will see the current measurement on the screen.

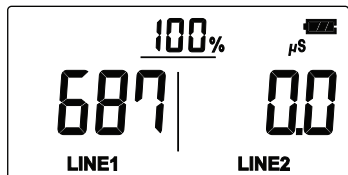

Example, if you put 700uS then 687sS is appeared.

4. Press and hold IN/CAL button for 5 seconds.

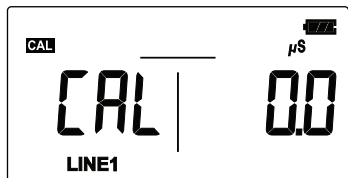

If you want to change LINE 2, press OUT button then you can change it.

5. Then press ENTER button, and the SET icon will be appeared.

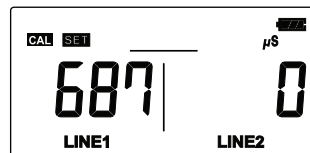

And during this stage, you can change the measurement pressing UP/DOWN button.

6. Like picture, press UP button and change to 700uS,

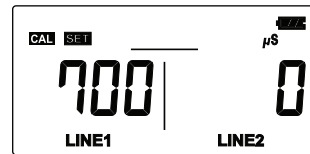

7. Press and hold "ENTER" button until it is saved automatically.

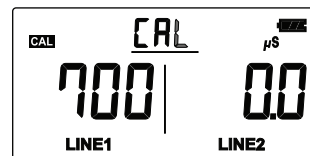

If the top of the screen shows, "C->CA->CAL", it is saving.

8. Then, like picture, after "END" will be appeared then in three seconds the calibration measurement will be saved and then the screen mode will be changed to general calibration mode.

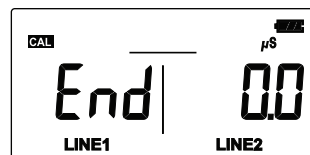

※ You must do same process for LINE 2 separately. As in 4 above, you can change LINE 2 for the sensor selection and then you can follow the same process.

**[OVERVIEW]**

Thank you for purchasing HM Digital's mini controller LDM-100R. The LDM has a dual sensors, it is a benefit that users can watch incoming and outgoing numbers at the same time and it also has Rejection function so you can see the rate of purifying as % and it also shows you the time of the filter replacement.

**[Specifications]**

- EC Range: 0 ~ 9999  $\mu$ S( $\mu$ S/cm) ; 0.0 ~ 20.00mS (NaCl)
- TDS Range: 0 ~ 9999 ppm (mg/L); 0.0 ~ 10.00 ppt (NaCl)
- Resolution: 0-99: 0.1  $\mu$ S/ppm  
100-9999: 1  $\mu$ S/ppm  
0.01 mS/ppt

Accuracy: +/- 2%

Temperature Compensation: Yes (1 - 65°C)

EC ,TDS Factor: NaCl (avg. 0.5)

Calibration: Digital calibration

Dual Sensor: 1/2" bushing, 3 meter (9.8 ft) shielded cable

Power Source: 1.5V x 2EA (AA SIZE)

Dimensions: 120x75x26 mm

Weight: 198g (Include Batteries)

**[Sensor Assembling]** LINE 1 must be connected to IN, and LINE 2 must be connected to OUT.

**[LCD Screen & Housing Images]**

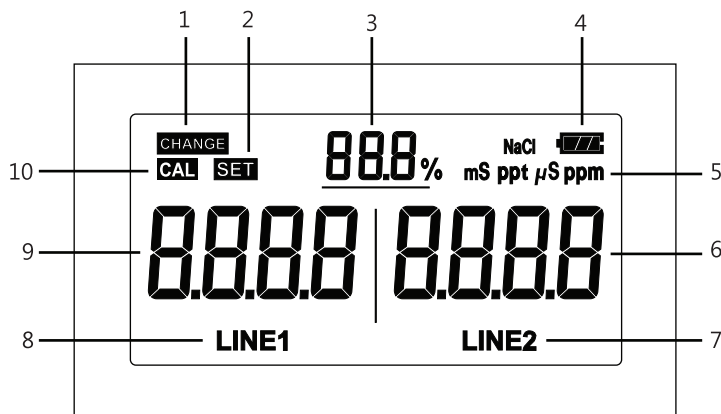

1. Filter change icon
2. Set mode icon
3. Rejection measurement
4. Battery icon
5. Unit mode icon
6. LINE2's measurement
7. LINE2 (out-line) icon
8. LINE1 (in-line) icon
9. LINE1's measurement
10. Calibration

